

Environmental Education

(For 11th class)



Writer : Prof. S.K. Gupta
Dr. Charan Kumar Joshi
Varinder Kumar

Vetter : Dr. H.S Rose

Artist : Gurmail Singh

Subjet Coordinator : Dr. Shruti Shukla

ਇਹ ਪੁਸਤਕ ਪੰਜਾਬ ਸਰਕਾਰ ਦੁਆਰਾ ਮੁਫਤ
ਦਿੱਤੀ ਜਾਣੀ ਹੈ ਅਤੇ ਵਿਕਰੀ ਲਈ ਨਹੀਂ ਹੈ।



Punjab School Education Board

Sahibzada Ajit Singh Nagar

© Punjab Government

Edition : 2021-22.....11,000 copies

All rights, including those of translation, reproduction and annotation, etc., are reserved by the Punjab Government

Warning

1. The Agency-holders shall not add any extra binding with a view to charge extra money for the binding. (Ref. CI. No.7 of agreement with Agency-holders).
2. Printing, Publishing, Stocking, Holding or Selling etc., of spurious Text-books qua text-books printed and published by the Punjab School Education Board is a cognizable offence under Indian Penal Code.
(The text-books of the Punjab School Education Board are printed on paper carrying watermark of the Board).

ਇਹ ਪੁਸਤਕ ਵਿਕਰੀ ਲਈ ਨਹੀਂ ਹੈ।

FOREWORD

Ever since its inception, the Punjab School Education Board has been continuously engaged in framing the syllabuses at the school level and in preparing text-books according to these syllabuses.

Punjab School Education Board decided to adopt the syllabus in the subject of 'Environment Education' prescribed by the N.C.E.R.T. of all the classes at school level. In order to lessen the burden of studies on the students of primary classes under the National Education Policy. Punjab School Education Board has introduced a new subject 'Environmental Education' by combining the subjects of Social Studies and Science. In classes VI to X it has been introduced as an essential component of Science subject, whereas in senior secondary classes it has been introduced as an independent compulsory subject. However the text-books of this subject for these classes have been prepared keeping in view the academic needs of the state of Punjab.

The book in hand has been prepared for the student of class XI. Sincere efforts have been made to make this book interesting with the help of additional information and designs. This book has been edited by Sh. Dharam Singh, Subject Expert under the guidance of Director Academic.

The book is offered with the hope that both the students the teachers will find its study rewarding. Suggestions for further improving the book from the field will be cordially accepted by the Board.

Chairman
Punjab School Education Board

‘ਸਮਾਜਿਕ ਨਿਆਂ ਅਧਿਕਾਰਤਾ ਅਤੇ ਘੱਟ ਗਿਣਤੀ ਵਿਭਾਗ’, ਪੰਜਾਬ

Contents

Sr. No.	Chapter	Page No.
1.	Environment	1
2.	Population and Environment	8
3.	Impact of Human Activities on Environment	13
4.	Economic and Social Development	23
5.	Impact of Liberalisation and Globalisation	29
6.	Role of Society in Development and Environment	33
7.	Environmental Pollution	38
8.	Pollutants and Diseases	44
9.	Global Issues and Improvement of Environment	50
10.	Disasters	58
11.	Energy Consumption	65
12.	Conventional Sources of Energy	71
13.	Non-Conventional Sources of Energy	76
14.	Conservation of Energy	89
15.	Safe Work Environment	96
16.	Safety Laws, Accidents and First-Aid	105
17.	Drugs - ILL Effects-I	113

CHAPTER-1

ENVIRONMENT

In strict sense, environment means “that which surrounds”. In the broadest sense this includes energy and matter capable of influencing man and other organisms. But in practical terms, it is the medium or specific surroundings, which interact with the organisms for their adaptation. This is called “natural environment”. Environment can also be defined as the sum total of conditions that surround a man at a given point in space and time. In prehistoric days, by and large, man lived in harmony with nature, but presently man is exploiting nature and the environment is changing steadily with the passage of time. As such, environmental conditions of people living in hills are different from those living in plains and deserts. Thus environment changes with space and is not same at all the places.

COMPONENTS OF ENVIRONMENT

The components of environment are divided into two categories:

- (i) **Abiotic components:** These are non-living components. These include climatic components such as energy, rainfall, solar radiation, temperature, wind and water currents; chemical components like oxygen, carbon dioxide, acidity, salinity and inorganic nutrients of plants, and physical components such as soil, air, light and geomagnetism. Though non-living, yet all these components are essential for the life of man and other organisms.
- (ii) **Biotic components:** These are the living components of the environment, which include micro-organisms (the decomposers), plants (the producers) and the animals including man (the consumers).

The interaction of abiotic and biotic components results in a stable self-perpetuating system. In this interaction, energy plays a crucial role. The main source of energy is the sun. Some of this solar energy is utilized by green plants through photosynthesis and conversion of this energy takes place into chemical energy in the form of food. The animals directly or indirectly obtain their energy from the plants. When the animals die, their bodies are decomposed by the micro-organisms, in this way, they again transfer this energy back to the environment.

DIMENSIONS OF ENVIRONMENT

Environment has three dimensions : (i) **Physical** (ii) **Biological** (iii) **Social**

- (i) **Physical Environment:** There are three main physical components of the environment i.e. atmosphere, hydrosphere and lithosphere (Fig 1.1).

The atmosphere is an envelope of life having gases like oxygen and carbon dioxide that covers the planet earth. Oxygen is used by animals including man for oxidation of food to get energy to perform different activities of life. Carbon dioxide is used by plants to manufacture

their food. Atmosphere acts as a greenhouse as it protects our planet from scorching heat of the sun during day time and extremely low temperature at night. It also serves as a store house of water vapours which leads to rainfall.

The hydrosphere includes water on the surface of earth in the form of oceans, lakes, rivers and other water bodies. Water is essential for metabolism in all living organisms and thus it is called 'cradle of life'. It also plays a role in moderating the temperature conditions of the environment.

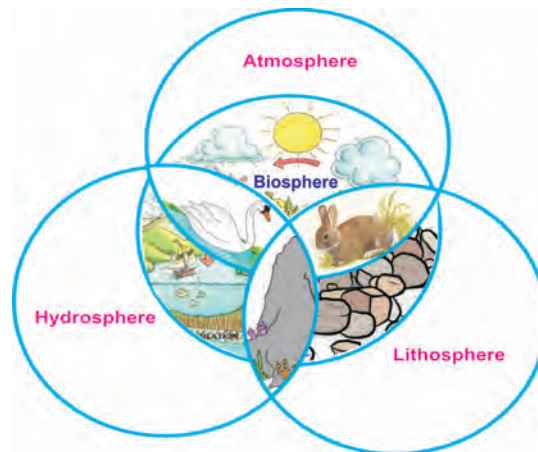

Fig 1.1 Biosphere

The lithosphere literally means raw materials on the earth's surface. It provides minerals and soil for growth of the plants, animals and microorganisms. A narrow zone formed at or close to the interfaces between atmosphere, hydrosphere and lithosphere, is known as biosphere. As all the life exists in this zone, thus it is called “life zone of earth”. The plants and animals are found in the zone of contact between atmosphere and lithosphere. Similarly, the zone of contact between hydrosphere and lithosphere is rich in organisms dwelling on the sea shores and shallow water of the sea.

- (ii) **Biological Environment :** The biological environment includes all the living organisms. They are further differentiated on the basis of their nutritional relationships into producers (autotrophs) consumers (heterotrophs) and decomposers.

The photosynthesis bacteria and green plants are included in the category of producers because they synthesize their own complex organic food from water, minerals, CO₂ and sunlight through photosynthesis. They serve to provide food to the entire biological environment.

All animals, including man come under the category of consumers because they cannot synthesize their organic requirement or food of their own. They have to depend upon plants for their food. They are further classified into two groups (a) primary consumers (b) secondary consumers :

- (a) Primary consumers are herbivorous animals as they directly consume plants as their food, e.g., hare, deer, elephants etc.
- (b) Secondary consumers are carnivorous animals as they feed on herbivorous animals, e.g., lion, tiger, leopard, etc.

Most of the micro-organisms, which mainly include bacteria, fungi and some macro-organisms like worms and insects, are included in the category of decomposers. They breakdown dead organic material into smaller particles and finally into simpler substances that are used by plants as nutrients. Thus decomposers play a vital role in nature, because without them, all nutrients would be tied up as dead matter and no new life would be produced.

- (iii) **Social Environment :** Man lives in an environment where both abiotic and biotic factors affect him. Considered to be the most intelligent of all living beings, man has adapted himself to these factors in several ways. Since his appearance on earth, he brought agricultural revolution for fulfilling his demands in terms of food and fibre. He has developed methods to cultivate slopes of mountains through terrace farming. The construction of dams on fast flowing rivers led to the generation of electricity, being used to develop industry. The network of canals has been created for irrigation purposes. He has created different means of transportation to move from one place to another for earning his bread and butter. The industrial revolution made man's life comfortable in more than one way.

Social environment also includes cultural aspects and social values. Political, economic and religious institutions constitute an important part of the social environment and often decide how the environmental resources should be used by man.

HUMAN BEING AS RATIONAL AND SOCIAL PARTNER

IN ENVIRONMENT ACTION

So far, we have discussed only the natural environment, which has not been altered by man. It is often called 'nature'. But today, there is hardly any area where man has not intruded himself.

He has conquered the highest peaks of the mountains, ventured in tropical rain forests, bottoms of the ocean and even Antarctica, the coldest region of the earth. Thus in present context, environment may be taken as totality of natural and man made environment. The latter includes agriculture, mining, industrialization, housing and building of cities etc. Man has used his skills to build multistorey buildings, roads, bridges, railways, airports, seaports, tunnels, water-supply lines, cables for telecommunications, sewers and several others kinds of infrastructures. Though these changes have improved the living conditions of the people, yet due to overexploitation of the natural resources, the physical, chemical and biological properties of water, air and land have vastly changed. The changed environment is suspected to create a lot of problems for the man himself. To avoid deterioration and degradation, many environmental societies and organizations have started warning the people through posters, rallies, lectures, film shows etc. regarding the harmful effects of overexploitation of natural resources. The local Governments do support such a noble cause. As a consequence of this, many countries have earmarked several areas which have been kept free from human interference. Such areas are called as Biosphere Reserves, National Parks and Wildlife Sanctuaries. Also, in the name of environment Governments have tried to convert these protected

areas into recreational spots without giving such emphasis on long term ecological consequences. The environmentalists and conservationists are quite conscious about such actions as these.

SOCIETY AND ENVIRONMENT

Society is a group of interacting people who live in a specific geographical area in organised cooperative manners, sharing a common culture. Thus it is very clear that human society and natural environment are intimately tied to each other. Since the dawn of human civilization, many social groups/societies have evolved. They have adjusted themselves as per their natural environment. For example, where the natural environment provided fertile land, the people started agriculture as their profession and became a society of agriculturists as in Punjab, Haryana, Uttar Pradesh, etc. In other regions, where natural environment was rich in coal and minerals, the people started mining as in the regions of Bihar and Jharkhand.

Cultural factors also affect the natural factors. Culture may be defined as the man-made part of the environment. It determines social environment and social actions. According to a Poritish anthropologist Edward Burnett Tylor, “Culture is that complex whole which includes knowledge, belief, art, law, morals, custom & any other capabilities & habits acquired by man as a member of society”. The role of cultural factors on natural factors can be best understood by the following examples. In an agricultural society. Irrigation of land is a main requirement. As a result, the rivers are dammed to channel the water through canals. If the rivers are not available in nearby area, people will irrigate their fertile land through tube-wells. In Punjab, the level of ground water has lowered considerably due to overuse of tube-wells. Thus agriculture which is a cultural feature has affected the nature. Similarly, the industrial culture of the present society has polluted the commons i.e. water, air and soil.

It is the foremost duty of every individual of the society to realise that if we go on destroying the natural environment and natural resources it may lead to a dark future for the coming generations. Let the society, Governments and Non-Government Organisations (NGOs) do something concrete to improve the environment. Most important aspect for the improvement of the natural environment is an active participation of general public in this noble venture. The public interest in improvement of the environment is different at different times. According to “Issue Attention Cycle” put foward by Down, there are five stages to complete the cycle of changes in the public interest. These are:

Stage one: It is the stage when the public is not aware of environmental problems.

Stage two: It is the stage when the attention of the public is drawn towards environmental problems by different types of media or through actual observations. People show their interest and respond to any measure to be taken without caring for the cost involved in it.

Stage Three : At this stage people show keen interest in the improvement and realise the cost involved in the process of development. The people also understand that technological development is not the best solution to the environmental improvement.

Stage Four : At this stage the public interest begins to decline due to two reasons. Firstly, they find

difficulty in implementation of improvement programmes due to indifferent and non-cooperative attitude of agencies working in the field. Secondly, the higher cost of environment measures also dampens their interest.

Stage Five: Finally the public interest becomes intermittent. Sometimes it decreases and at other times it again increases.

According to Down, at present the situation is approximately in the middle of the “Issue Attention Cycle.”

DIFFERENT TYPES OF SOCIAL SYSTEMS AND THEIR IMPACT

Different types of social and political systems also affect the environmental problems and their solutions. As usual, there are two kinds of societies found in many countries of world i.e., capitalistic and socialistic societies. Though both the societies are very much concerned with improvement of the natural environment, yet their approach varies due to different types of industries, different level of development and more so by, different view points of their governments.

In capitalistic societies, the main aim is maximum production with maximum profit. The high technological developments in such a society have led to an unparallel growth of economy. The interest of such companies lies in overexploitation of natural resources for their selfish ends. This type of development leads to ecological imbalance.

On the contrary, the socialistic societies, feel more concerned about the importance of natural resources, environment and ecological problems. Such societies generally set up good traditions to prevent exploitation of natural resources and to have harmony between man and nature. The concept of involvement of society in the production and consumption of natural resources develops a sense of belonging. In such societies, people weigh merits and demerits and are mostly conscious of the uses and misuses of their natural resources.

INDIAN TRADITIONS, CUSTOMS AND CULTURE-PAST AND PRESENT

The science of Ethology (study of human behaviour) states that “Man is a creature of customs and culture”. In fact, human culture and environment are intimately tied to each other by a feedback process. Let us study this relationship under two headings: (i) Past customs and culture (ii) Present customs and culture.

- (i) **Past Customs and Culture:** The earliest record of our past customs and culture is found in “Rig Veda”, the first written document of our civilization. It provides a very illustrative account of the five basic elements of our environment- the earth, water, air, energy and space. Man is ordained to conserve and use these elements judiciously for the prosperity of mankind, It clearly defines man's obligations towards the protection of all natural resources, including plant and animal kingdoms. The “Upanishads” explain the need for putting restraint on use of natural resources in order to protect the interests of future generations. It is perhaps because of this reason that trees have been an object of worship in our country and cutting of trees has been religiously prohibited. From this, one can clearly make out that conservation of the environment has been an integral part of the society in the past.

(ii) **Present Customs and Culture:** The present day customs and culture of our society are also related to the environment. For example, in Jammu and Kashmir, the climate is quite cold and that is why the people living there wear *phiran* (a long coat) and keep *kangri* (a type of heater) to keep their body warm. They drink a special type of tea called *kahwah* to maintain their body temperature. On the other hand in Rajasthan (part of Thar Desert), due to sandy soil, the days are very hot and because of this reason they wear a long turban (14 meters) that act as air conditioner for them. They also keep long moustaches to protect their nostrils and mouth from dust. The women folk keep a long *ghongat* (a type of 'parda', veil) to protect themselves from dust and scorching heat.

In south Indian states, the environment is hot and humid and that is why the people there wear a cotton *lungi* (a type of *dhoti*), cotton *kurta* and mostly keep an *angvastra* (a type of towel) on their shoulder. Similarly, one learns ones native language, eating habits, games, workmanship, life style, worship methods and also death rituals that conform to ones own cultural traditions.

The distribution of natural resources on the planet earth has also lead to the development of varied cultures. Say in India, the fertile soil in areas like Punjab, Haryana and Uttar Pradesh has generated the occupation of agriculture. The mines of Jharkhand have created occupation of mining and industries related to it. The existence of sea shore along the coastal areas has created the occupation of fishing and related industries.

No doubt, human culture and natural environment are interrelated, but a change in one perturbs the other, which, in turn, stirs up more ripples. Now-a-days, the Indian culture tends to have a shift towards the Western culture. As a result of this, some subtle changes in the environment may show their head in future years. The arrival of multinational companies in India may start exploitation of our natural resources purely for profit and greed. In the long run, it may create problems for us. Let us learn from the past, incorporate it in the present and pass it on to the future to have clean and pollution free environment.

EXERCISE

(A) Very short answer type questions (1 mark each) :

1. What is natural environment?
2. Name the components of the environment.
3. Give three dimensions of the environment.
4. Define autotrophs.
5. What are heterotrophs?
6. Name the components of social environment.

7. What are biosphere reserves?
8. What are the five elements of our environment?

(B) Short answer type questions (2 marks each) :

1. Differentiate between abiotic and biotic components?
2. Why socialistics society is better for the conservation of environment?
3. Differentiate between Lithosphere and Hydrosphere.
4. Justify that producers are most important for the biological environment.

(C) Short answer type questions (4 marks each):

1. Comment upon the role of public in protecting the environment?
2. Give a detailed account of the physical environment.
3. How will you explain that man is a rational and social partner in environmental action?
4. Explain the details of biological environment.

(D) Long answer type questions: (5 marks each):

1. Discuss the five stages of “Issue Attention Cycle” of Down.
2. Give a brief account of India's past and present customs and culture. Which one is better in your opinion?



CHAPTER-2

POPULATION AND ENVIRONMENT

As an evolutionary unit, population may be defined as a group of similarly adapted, interbreeding organisms belonging to the same species. However, with respect to environment, population is defined as organisms or members of the same species living and interacting in a particular geographical area. *Homo sapiens* is the highly evolved species and in this chapter we shall deal with human population only. Being the most intelligent, man has the ability to change the environment for his own well being. Due to an increase in human population, various activities of man have raised many environmental issues and problems. In this context, scientific studies of populations are necessary to understand its impact on environment. These studies include population growth, distribution, density, literacy, urbanization etc. These are likely to be useful in understanding problems being faced by man in agriculture, economic planning, wild life management etc.

Before considering all these aspects, it is essential to know some common terms used in demography (Fig. 2.1). It is the study of population in all aspects like number, sex ratio, age groups, emigration, immigration etc.

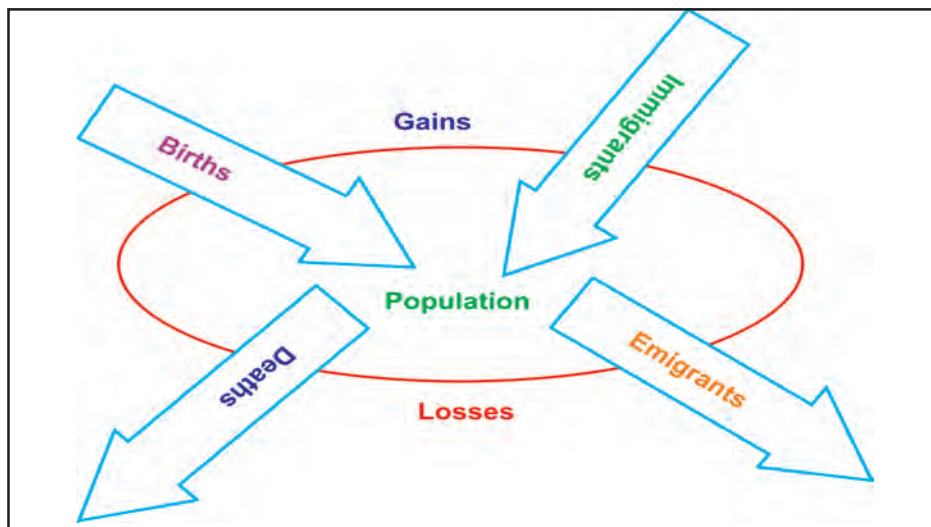

Fig. 2.1 Aspects of demography

Population density : It refers to the number of human beings living in a unit of space, normally expressed as per square kilometer.

Birth rate : It deals with rate of addition of newly born individuals in a population. It is also referred to as natality rate. It is usually expressed as the number of births per year per thousand persons in a population. It is also referred to as natality rate.

Death rate: It refers to the rate of individuals which are lost by way of deaths. It is expressed as the number of deaths per year per thousand persons in a population. It is also called mortality rate.

Migration: It is the movement of people to new places either within the same country (internal migration) or to another country (external migration). When new people are added from outside, it is called immigration and if they move out from a population, it is called emigration.

Age structure of population : It refers to proportion of individuals of different age groups in a population.

Sex ratio : It is the number of female per thousand of males.

POPULATION THEORIES

Man has been concerned with the population of his own species since ancient times, but recently it has been felt that population dynamics influences human welfare.

One of the earliest theories of population dynamics was proposed by Plato and Aristotle. It states that the optimum size of a population is that in which man's potentialities can be carefully developed. It is possible only when the population size is economically self sufficient and is capable of defending itself.

At the close of the 18th century, Thomas Robert Malthus (1798), a British economist and demographer published his theory of population in the form of "An Essay on the Principle of Population". According to him, population always increases geometrically (2, 4, 8, 16, 32.....), whereas, food and means of subsistence increase arithmetically (2, 4, 5, 8, 10.....) and thus there will always be an imbalance between population, food and space. Malthus concluded that if the population growth was not checked, the nature will play its role through checks such as wars, famines, droughts, tsunamis, disease etc. to decline the population.

POPULATION GROWTH

The most important aspect of population that affects the environment is population growth. As per record, the human population was about 0.6 billion in 1700 A.D. At the beginning of 20th century, it increased to 1.6 billions and by the end of this century, human population reached 6.1 billions. It took 150 years to double the population from 0.6 billion to 1.2 billions, but in the next 150 years, it increased five times. It is also believed that in the next 50 years, the population will cross 9 billion mark. As per UN estimate, the current annual growth rate of the world population is about 2.5%. The natality rate per minute is 234. Another interesting aspect of population growth is that it is not uniform everywhere throughout the globe. In fact, the distribution pattern of population varies in different regions. According to an estimate, about 20% world population lives in half of the total area of earth that includes Europe, North America, former USSR and Oceania. The rest of world population lives in the remaining half of the earth area. It includes all developing countries. The growth rate is also highest in developing countries e.g. the highest growth in the world is in Africa. In addition to the rising growth rate of developing countries e.g. population below 15 years is 45% in Africa and 22% in Europe. However, the percentage of population above 65 years is more in developed countries.

Due to obvious reasons, it is essential to know the carrying capacity of the environment. It is defined as the maximum population size that can be supported by the environment. For this purpose, environment has two components:

- (a) **Life supportive components:** It is the environment that provides food, energy, air and water.
- (b) **Waste assimilative components:** This part of the environment includes the assimilation of waste material produced by human activities.

As the carrying capacity of the earth is limited and, therefore, the outcome of the rapid growth of population produces harmful effect on the environment. The United Nations Environment Programme (UNEP) has worked out that the higher population growth will lead to poverty and an increased rate of environmental degradation.

Now, let us examine the impact of population growth or some components of carrying capacity of the environment.

- (i) **Impact on food :** Population growth has a direct relationship with food. The scarcity of food will lead to an overexploitation of land and other resources resulting in tension and conflict amongst human beings. Presently, 60% of the people in the world are underfed. In India about 70-80% children are suffering from malnutrition.
- (ii) **Impact on poverty :** Population and poverty are greatly related to each other. Any increases in population puts a pressure on basic necessities such as houses, jobs, medical facilities etc. It will lead to poverty. As a result, more and more people will become poor and poverty ridden.
- (iii) **Impact on raw materials :** An increase in population is directly related to an added pressure on industries to produce more and more goods to fulfill the demands of the people. There are two main sources of raw material i.e., the mines and the forests. Over mining operations to extract more coal, iron ores and other ores have led to the closure of many mines. Similarly, to get more timber, rubber and herbs, the forests are being destroyed. The loss of forests has a far reaching effect on the environment resulting in Green House Effect. It will lead to global warming. Due to rise in global temperature, the old glaciers have started melting and subsequently the sea level will rise and many islands and coastal areas will face a major threat of getting submerged under the water.
- (iv) **Impact on energy :** Most of the developed and developing countries of the world are heading towards heavy industrialization to create more jobs for the growing population and to produce more products to meet their demands, Industries cannot run without energy. The energy can be obtained from fossil fuels like coal, petroleum, natural gas, etc. Due to their over exploitation, they may start depleting very fast.

URBANISATION

Urbanisation means the number of people living in the cities. It has become a characteristic trend in human civilization to shift to cities. In the United States, only 6% population was living in cities in 1800, but at present more than 70% population lives in urban areas. In Netherlands, around 90% population lives in cities. At the global level, about 29% population was living in cities in 1950. In 1990 this figure rose to 43%. Due to expanding population, even the cities cross their administrative boundaries, leading to a chaotic situation. For example, to decrease the pressure of population on Delhi, the satellite towns like Noida, Faridabad, Ghaziabad and Gurgaon were developed but now they have almost become a part of Delhi itself. The same is the case with other bigger metros like Mumbai, Kolkata, Chennai etc. The principle cause of this growth is urbanization vis-a-vis industrialization. As more and more industries grow, people migrate from villages to cities to earn their livelihood. Another reason of their shifting to the cities is the availability of better medical and educational facilities. The mechanization in farming operations has further declined the need for farm labourers and thus they are also migrating to cities.

This unimaginative influx of population to almost all bigger cities has created scarcity of houses, drinking water, electricity, etc. The urbanization has led to a very serious problem, i.e., the growth of slum areas around the cities. The governments are always in a fix to solve the problems of the slums.

LITERACY

Literacy is an ability to read and write, but for the purpose of ecology, it is the educational level of the people of a country and the world. In 2001, the literacy rate of India was 64.8%, but if it is compared with Asia and Africa, it is only about 30% i.e. 70% people are illiterate. Illiterate people are sometimes considered as a burden on a country and a society as they cannot contribute in the development in a bigger way.

With environment as a subject, one can early see the difference between illiterates and literates. The literate societies tend to live in relatively clean environment. Without awareness people fail to differentiate between biodegradable and non-biodegradable substances that is why they do not shop using plastic bags and other such products. The use of plastic has created many environment problems, especially relating to sewage disposal and choking of water bodies.

Thus, to conclude, further population explosion needs to be avoided otherwise it will deteriorate the environment, beyond repair.

EXERCISE

(A) Very short answer type questions (1 mark each) :

1. What is demography?
2. Define birth rate.
3. Define death rate.

4. What is sex ratio?
5. What is responsible for population growth, emigration or immigration?
6. What is poverty?
7. Define literacy.

(B) Short answer type questions (2 marks each) :

1. Explain carrying capacity.
2. How population explosion has affected the food production?
3. Name four satellite towns?
4. What is the impact of population growth on energy?

(C) Short answer type questions (4 marks each):

1. What is Malthus theory on population?
2. How does are urbanisation affect the environment?

(D) Long answer type questions: (5 marks each):

1. Discuss the impact of population growth on various components of carrying capacity of the environment.



CHAPTER-3

IMPACT OF HUMAN ACTIVITIES ON ENVIRONMENT

During the 20th century, especially during the last two decades, science and technology have made an overall progress and advancement in many areas. On one hand, this advancement has given many comforts to man on the other hand, the progress made is proving counter productive in certain ways. Say for instance, this advancement has disrupted the fragile woven web of life, besides affecting the environment in a number of ways. Various human activities have been found to have varied impact on the environment, as evident from the following:

- Environmental problems of urban and rural areas
- Natural resources and their depletion
- Stress on civic amenities
- Vehicular emission
- Urbanisation

ENVIRONMENTAL PROBLEMS OF URBAN AND RURAL AREAS

The human society may be urban society, living in cities and towns or rural society, living in villages. Both the societies have their own environmental interaction and problems.

(i) **Urban problems:** The environmental problems of the urban areas are more serious than those of rural areas. This is an outcome of the modern consumerist culture i.e. industrialization and overcrowding. As the urban population grows, it adds strain to the supporting system of the environment, foremost of which is the pollution. It is found in the air we breathe, the water we drink, the food we eat and the sound we hear. In order to make it more clear, some specific problems can be referred to as follows:

- The growing population puts a lot of pressure on limited land in different cities. Also to expand the urban areas, large scale deforestation is being done. It along with burning of the fossil fuel is resulting in global warming. As the cost of the land rises, the poor people cannot afford land to construct their houses and as a result slums start developing around all major cities (Fig 3.1). Slums are unorganised and densely populated areas having poor standard of living conditions and open sewage system. The slums have open sewage system and become most unhygienic places around urban areas. The urban areas with growing population produce a lot of solid waste. Many environmental problems are created due to shortage of dumping sites for appropriate disposal. As the waste piles up, it reaches into water bodies and becomes a cause of many water borne diseases. These wastes also emit very foul smell. Besides they become breeding grounds for rodents and insects. Generally, these wastes are dumped into near by rivers or lakes that affect the aquatic flora and fauna (Fig. 3.2).



Fig. 3.1 A Slum

Polluted air is another problem of the urban areas due to industries and vehicular emission. Continuous inhaling of such air causes many respiratory problems. In winter months, due to low temperature the industrial smoke gets converted into smog. It is very harmful to eyes and lung. It also lowers the availability of sunlight. The burning of fossil fuels also produces sulphur dioxide. It combines with water vapours present in the atmosphere to form sulphuric acid. It becomes the cause of acid rain that affects our life in different ways.

The growing urban population creates an acute shortage of water and electricity. In summer month, people use generators to get continuous supply of electricity. The smoke and sound produced by these generators cause air and noise pollution respectively.



Fig. 3.2 Problem of waste water in urban area

- High cost of eatables, entertainment, education and medical facilities have also become a problem for urban people.

(ii) **Rural problems:** As far as, the environment is concerned, rural problems are comparatively less as compared to urban problems. The major rural problems are due to non availability or poor availability of services like education and medical facilities. In certain villages, there are no schools and the children have to go to nearby cities or towns for their education. The institutes for higher education are totally absent in many rural areas, thus most of the students, especially the girls do not go for higher studies. Some of those who go to the cities have to face financial problems due to high cost of living there. Similarly, in most of the villages, there are no hospitals or dispensaries. If at all these are present, they are ill equipped. They have to run to the cities for even minor ailments. The rural people have to depend upon hand pumps, ponds and wells to fulfill their water needs. The animals and washing of clothes in ponds pollute these water bodies. The pond water becomes a breeding ground of many insects particularly the mosquitoes. Open lavatory system, unhygienic sanitary conditions and improper drainage system also aggravate the environmental problems. In many villagers, facilities such as post office, telephone and baking are lacking.

In rural areas, the excessive use of chemical fertilizers, insecticides, weedicides and other pesticides for agricultural purposes pollute the water bodies (Fig 3.3). When used for drinking purposes, this water may become a cause of many serious diseases like cancer, etc. The excessive use of these chemicals have also resulted in the loss of biodiversity.



Fig. 3.3 Excessive use of pesticides

NATURAL RESOURCES AND THEIR DEPLETION

Natural resources consists of energy and matter obtained from the environment for the use of living organisms, including man. These resources can be classified as renewable and non-renewable. The renewable resources are those which can be replenished by the natural processes. These include soil, air, water, plants and animals. The non-renewable resources such as coal, iron ore, petroleum etc. cannot be replenished. There are four major causes of depletion, as follows:

- (1) Population growth
- (2) Over use of resources
- (3) Non equitable distribution of resources
- (4) New technological developments

(1) **Population growth :** There was a little depletion of natural resources when human population was small. As the population explosion took place in the 20th century, the demand for food, minerals, wood and other commodities increased. Forests were rapidly cut to get more food and woods bringing. To get more minerals for industries, the mines are overused and this destroys the ecosystem. To create more houses, new colonies and cities, the resources are used indiscriminately. Thus population growth leads to pollution, crowding, destruction of habitat and exhaustion of natural resources.

(2) **Over use of resources:** The growth in population is the main cause of overuse of natural resources like soil, water, minerals and forests.

(i) **Soil :** The soil supports all living organisms. The plants get their water and nutrients supply from the soil. The animals, including man get their food directly or indirectly from the soil. It also provides fibre, wood and many other products. Due to growing population, the soil is overused to grow more and more food. Though, soil is a renewable source, yet it needs time to replenish itself after every harvesting of a crop. But due to lust to grow more crops, many farmers do not keep the soil free even for few weeks after harvesting wheat. Say for instance, after harvesting wheat, they immediately sow a *sathi* variety of rice, followed by the regular variety of rice. It leads to greater loss of nutrients from the soil. It is being compensated by adding chemical fertilizers. But these fertilizers pollute both the soil and the water sources. Excessive use of pesticides also affects the soil adversely. Monoculture i.e., growing same crop every time also effects the fertility of the soil. Besides these factors, the soil is also degraded by over grazing and erosion caused by water and wind.

(ii) **Water :** Water is another important element in the biosphere and is essential for existence of all forms of life on the earth. All human activities and economic developments depend upon water directly or indirectly. It is a divine drink essential for sustaining life. Though, the planet earth is known to have 97% of water in oceans, yet it is of very little use to man due to salinity. The ground water is the main source of water for man, besides fresh water from rivers and lakes. The water is mainly consumed by human population and in agriculture and industries. It has been estimated that all over the world 65%, 25% and 5% water is used in agriculture, industry and domestic purposes respectively. The growing population and other fast developments lead to an overuse of water.

Underground water is considered to be a better natural resource. It gets recharged naturally by seepage from the surface as well as from underground water flows. It, however, needs some time to replenish the underground water. The excessive use of water for irrigation is considered to be main reason of water depletion. The other main factor for water depletion is its injudicious use by millions of people living in large cities. The surface water is also over used and contaminated by farm practices, industries and even by domestic wastes.

The population explosion has led to more extensive and larger network of dams and reservoirs. There are more than 36,000 dams in the world. This network regulates the water supply throughout the year. But it reduces the total flow because of loss through evaporation over larger surface area of such reservoirs. No doubt the dams provide electricity, help in controlling floods, provide irrigational facilities, but their adverse impact on the vegetation cover and the ecosystem cannot be ignored.

The ocean water is not used directly by man but it is a highly productive source of about 130 billion tonnes of food in the form of fishes, prawns, whales and other seafoods. In this respect also, the over use of marine food has lead to its depletion.

- (iii) **Minerals:** The Minerals come under non-renewable resources of the environment. It means that once they are depleted they cannot be replenished. Like other resources, due to an increase in population and industrialization, the per capita demand for energy is increased. To meet this demand, the fossil fuels are being over used. Similarly, minerals like manganese, copper, tin and zinc are extensively used to meet the urban needs. For example, on an average, each citizen uses 25kg of aluminium, 550kg of iron and 10kg of copper per year in the United States. In cities where lot of new construction is going on, requires huge amount of cement, bricks, limestone, marble, slate granite etc.

Oceans are well known reserves of many minerals like gold and petroleum. According to an estimate, ocean has about 1,250 billion barrels of petroleum and 10 billion tones of gold. By the year 1960, 100 billion barrels of petroleum has already been extracted.

Thus it is evident that if an over exploitation of these resources continues at the present rate, they will exhaust in few decades.

- (ii) **Forests:** Forests are vital for our environment. They play an important role in maintaining global ecosystem at various levels. The important functions of the forests are: the supply of timber for housing, wood for fuel, raw materials for the forest based industries, prevention of soil erosion and preservation of watersheds. The forests prevent siltation of the dams. They also maintain earth's temperature. Above all, forests provide habitat for rare plants and animals.

The forests are being destroyed indiscriminately for industrilization, urbanisation and mining. (Fig 3.4). In India alone, 22 million hectare forests have been destroyed during the last three decades. The de-



Fig. 3.4 effect of Urbanisation

forestation will lead to soil erosion, recurrent flooding, loss of rare animal and plant species, besides significant changes in the climate. All such changes will put a serious impact on human health and economy.

- (3) **Non equitable distribution of resources:** The natural resources are not uniformly distributed and thus there are many problems in their utilization. For example, Mesabi range of the USA is rich in iron ore reserves and an over-utilization of these reserves resulted into closure of many mines. On the other hand, due to rough and harsh climatic conditions of Eastern part of Russia, its mines rich in tin and gold remain unutilized.

Unequal distribution of resources increases the cost of production, as the industries have to transport raw material from long distance. For instance, Japan is an highly industrialized country of the world but it has no raw material of its own and thus they have to import raw materials from other countries.

Unequal distribution is a cause of many disputes amongst different states of India and also between many countries. The Satluj Yamuna Link canal has created dispute between Punjab and Haryana. Similarly, Cauvery river is a dispute between Kerala and Tamilnadu. At international level, there is a dispute of Mekong river that passes through China, Myanmar, Laos, Thailand, Cambodia and Vietnam.

- (4) **New technological developments:** As per anthropological records, the earliest human society consisted of hunters and gatherers. The first great revolution took place during stone age, when man started agriculture along with domestication of animals. It was most suitable because of less population and limited needs of the man at that time. It provided a some sort of stable ecosystem to that society. As the population started increasing, the then agricultural practices could not meet its requirements and the second great revolution took place. An industrial revolution started in 18th century in England. The raw material for the industries was mainly the minerals or agricultural products. Since then, to meet the demands of industries both these resources have been over utilized.

The present age is the age of technology. It invents new, fast and efficient methods for the industry. The most significant of these technologies are nanotechnology, biotechnology and bioinformatics etc. These technologies are expected to be of great use in treating most dangerous diseases, inventing alternative sources of energy, cheap and protein rich foods etc.

STRESS ON CIVIC AMENITIES

According to Oxford Dictionary, the term 'civic' is connected with city or town and the term 'amenity' refers to the features that make a place pleasant or easy to live in. Thus in composite way, civic amenities refer to the facilities provided by civic administrative to the peoples dwelling in cities and towns to make their life comfortable. Such facilities include clean drinking water, regular supply of electricity, transportation, medical facilities and disposal of wastes.

- (1) **Clean drinking water:** The supply of clean drinking water is the foremost responsibility of civic administration because most of the disease are directly or indirectly related to water. According to an estimate, 25 million people die every year from disease caused by unsafe drinking water in the developing countries. About 30% of people do not have access to safe drinking water. In many rural areas, women and children have to spend many hours a day to fetch water to fulfill their daily needs. In big cities, due to increasing population and excessive use of water, there is generally a shortage of clean drinking water, especially during summer months. During the rainy season, the contamination of water takes place in certain areas having faulty infrastructure and that poses serious health problems.
- (2) **Regular supply of electricity :** Electricity is another basic amenity, especially of the present generation. Most of the electricity is used by industries and farms and there is mostly a shortage of electricity for the domestic purposes. In summer season, this problem becomes more acute due to the use of air conditioners. Due to non availability of electricity, people use generators that become a cause of noise and air pollution.
- (3) **Transportation :** In big cities, people have to travel long distance for attending their duties. In most of the cities, there is no efficient public transport system and as a result there is a traffic jam during the peak hours. The poor quality of public transport causes lot of air and noise pollution. Even within over crowded cities cars, scooters, three wheelers intermingle with bicycles, rickshaws and pedestrians and result in frequent traffic jams.
- (4) **Medical facilities:** The health of a nation depends upon its healthy inhabitants. Increase in the volume and growth of human population put a pressure on existing hospitals and health centres. From time to time the civic administration has to open new hospitals, besides upgrading the existing ones to meet the ever increasing demands of the people.
- (5) **Disposal of waste:** Wastes are the products which are no apparent use. Such wastes are produced by human beings, agriculture and industries. Each Indian individual generates 250-300 gm of waste per day. Mumbai is the largest waste generator of India which produces about 5000 tons of waste per day. Thus, it has become the foremost duty of the civic administration to dispose of the waste through safe methods. Disposal of the liquid waste or sewage is more difficult, especially during rainy season. The disposal of wastes in cities presents a grim picture.

In some cities the wastes are thrown into rivers. It is estimated that about 900 million litres of sewerage and industrial wastes enter the sacred Ganges river every day. Defecation along the banks of river is another common practice followed by the people living in slums of big cities.

VEHICULAR EMISSION

It includes the pollutants added into the environment by automobiles aircraft etc. Automobile exhaust contains unburnt hydrocarbons which produce photo-chemically active formaldehydes responsible for irritation in the eyes. The main source of carbon monoxide in the environment is the

automobiles. When inhaled by man, carbon monoxide cause many respiratory problems. The emission also contains carbon, sulphur and nitrogen. Their reaction with each other in the presence of ultraviolet sunlight is very harmful. The nitrogen oxides of the emission react with particulate present in the air in the presence of sunlight and produce smog. Smog becomes a general phenomenon in big cities during winter. It reduces visibility that becomes the cause of accidents. It also causes irritation in eyes, throat and lungs. The emission is also very rich in carbon dioxide which creates green house effect in the environment. It is responsible for global warming.

URBANISATION

It is the process by which large numbers of people get permanently settled in cities. As per census of 1961 and 1971, the urban area is defined as the area that include

- The area having a minimum population of 5000.
- It should have notified area committee, or cantonment, or municipality or a corporation.
- Its population density is more than 1000 persons per square kilometer.
- At least 70% of male population is employed in jobs, other than agriculture.

The combination of technological and other development activities lead to a major increase in the process of urbanization and this has affected the land use, housing, migration and floating population. Let us study these effects one by one.

- (1) **Land use :** India has the fourth largest urban population in the world. In 1981, its urban population was 159.73 millions. As the urban population grows, new cities and towns make their appearance. Such establishments use productive land and rich forest areas for their settlements. Thus land with all its biological resources is lost.

The pattern is use of land in India is different from the western countries where specific areas are used for specific activities. In India, on the othe hand, the residential, industrial and commercial activities are taking place at the same place or even within the same street. The substantial fraction of urban population lives at the back or on the upper storey of their shops. The industrial areas are also mixed up with residential and shopping complexes. This type of mixing is due to the tendency of the people to live nearer to their working place and to be near the service centers to avoid the journey. Another peculiar feature of Indian cities is, that, a large number of service units use the road sides, street sides or other public places for their business. For example, the *rehriwalas* use any part of the open land for putting their *rehris*.

- (2) **Housing:** The problem of housing is directly related to the increasing population in cities and towns. For example, it has been estimated that Delhi needs 80,000 new houses every year. The housing demands and infrastructural shortage was accumulated over the years and is now beyond any appropriate solution.

On the other hand, the urban have solved their problem by building clusters of huts wherever they find any open place may be around the cities or even the surroundings of the villages.

This results into slums. The activities of the slums are worst for environment degradation. Dharavi in Mumbai is Asia's largest slum. It has spread over 4.5 square kilometer of prime land of central Mumbai. Its stable population is estimated to be around three lacs and on an average eight persons live in each hutment.

- (3) **Migration** : In most of the urban areas, the majority of the people are not of urban origin. In fact, they have migrated from non-urban areas or reasons such as employment, business, education, etc. People working in state government departments migrate from one city to another because of transfers. Similarly, the military personals and those who are employers of central government have to migrate from one end of the country to another. The people working as salesman keep moving constantly. Due to this, a family has to bear lot of stress. Not only that it has to move its household but also it has to adapt to new living conditions, new neighbours, new house, etc.
- (4) **Floating population** : It comprises people who commute daily from one place to another to earn their bread and butter. Ludhiana in Punjab and Chandigarh (Union Territory) have a substantial number of people that daily travel by buses or trains to their working place. At the national level, same is the case in Delhi and Mumbai. The bulk of this floating population comprises the middle class.

It can be concluded that urbanisation has varied impact on the environment. On one hand, it has deteriorated the environment both physically and mentally and on the other hand, urbanization is unavoidable for a developing society.

EXERCISE

(A) Very short answer type questions (1 mark each) :

1. What is urbanisation?
2. What are slums?
3. Define groundwater.
4. What is rotation of crops?
5. What is smog?
6. How is the green house effect created?
7. Name the minerals that can be obtained from sea floor?

(B) Short answer type questions (2 marks each) :

1. How does migration influence urban environment?
2. Write a short note on floating population.
3. Why are people shifting to urban areas, give reasons?
4. Name two human activities that lead to soil erosion?

5. Write a note on vehicular emission.
6. How has human activities resulted in depletion of forests?

(C) Short answer type questions (4 marks each):

1. What are the effects of non equitable distribution of natural resources on the development?
2. How are land and water being polluted by the urban people?
3. Write a short note on land use pattern.
4. Discuss main problems of urban areas.

(D) Long answer type questions: (5 marks each):

1. How are civic amenities necessary for improvement of life? What will be the impact of population explosion on these amenities?
2. Discuss the environmental problems of the rural areas?



CHAPTER-4

ECONOMIC AND SOCIAL DEVELOPMENT

Development literally means the gradual growth of the society so that it becomes stronger and advanced. There are two basic considerations of the development i.e., economic development and social development.

ECONOMIC DEVELOPMENT

Economic development refers to rise in the per capita income of the society. The activities responsible for economic development are cultivation, manufacturing, fishing, food processing, mining etc. Economic growth and development is necessary to bring about a change in the economic and social needs of the people. Economic growth leads to higher standards of living and improved social and cultural amenities.

The economic development of a country/state depend upon several factors like:

- The total area of the country/state
- The size and rate of growth of population
- Availability of natural resources or raw materials
- Land- man ratio
- The industrial and technological growth
- The availability of employment
- The level of per capita production
- Educational background of its people
- Racial composition of the people
- Economic policies of the country/state

Though agricultural sector is quite viable, yet it has limited scope for increasing the per capita income. It has limitations to lower the unemployment rate. On the other hand, the industrial sector is more diversified and generate a lot of employment opportunities. The service sectors like telecommunication, trade and commerce also provide a wide range of employment opportunities.

SOCIAL DEVELOPMENT

Both the economic development and social development are complementary to each other. The social development creates social needs like longevity of life, good medical and health care, education, status of women, absence of child marriage, child labour, etc. Most of the developed nations like the USA have invested their wealth to fulfill their social needs. But many developing countries including India are still struggling to provide basic amenities to their people. They have not been able to achieve acceptable living standard for their people.

Among the social needs, education is of foremost importance. It can help in reducing population, as evident from educated people who generally limit their family size to one or two children.

Education also leads to late marriage that reduces the span of fertility period leading to slower population. Education can provide various vocational facilities that improve the chances of employment. In many countries, education level of women is very low and that is why they do not enjoy respectable status in the society. However, after independence the status of the woman has greatly improved and there is hardly any field which has not been occupied by women today. Yet a lot remains to be done. For example, child labour and child marriage are major problems in many Asian countries. It is both due to lack of education and poor financial position of such families.

Longevity of life coupled with good medical and health care is another basic social need of the people. The developed countries spend a lot of money on projects involving public health, hygiene and health care. The USA spends about \$ 156 billion every year to ensure better health of their people. The World Health Organisation (WHO) at the international level is doing a yeoman's service to prevent the spread of many communicable diseases. The Government of India is also doing its best to raise the health standard of the people, especially, the women and the children. However, due to over population, this facility does not reach the poor people.

AGRICULTURE AND INDUSTRY AS MAJOR SECTORS OF DEVELOPMENT

Agriculture and Industry are two major components meant for the development of a nation. Both are equally for an overall development of a country.

Agriculture : Early human beings used to depend on hunting and gathering food for their livelihood and survival. With the passage of time, man's quest for stable source of living led to emergence of agricultural societies about 10,000 years ago. The early agriculture without use of any machinery was called as traditional agriculture. The farmers ploughed the land and made simple tools for tillage of their own. They raised livestock and ventured for fish farms also. Their primary goal was to produce food and other items for their own family. Yet, if they had surplus crops, the same were tried for trade or commerce on a much smaller scale.

With an advancement in agricultural technology, new developments like farm machinery became frequent and markets for agricultural products started growing at a faster rate. There was an evident shift from traditional agriculture to modern agriculture in the middle of 20th century. The addition of modern equipments, electric power, irrigation gadgets, fertilizers, plant protection chemicals and high yielding varieties led to green revolution in agriculture. The mass production of food and fibre led to establishing of processing units followed by distribution of food and creation of textile industry. Due to urbanisation, the demand for agricultural products started increasing with each passing day, It led to a new business called agribusiness. The following are the three aspects of agribusiness:

- (i) To manufacture farm equipment and other agricultural appliance.
- (ii) Farm grower-producer operations.
- (iii) Storage, processing and distribution of farm products.

The agribusiness has led to the development of new industries like farm implement companies, meat processors, food canaries, cold stores and freezers etc. No doubt, the modern agriculture has brought enormous increase in production, yet it caused irreparable damage to the natural balance of ecosystem.

Industry : Industries are the means of conversion of raw materials into finished products for human use. In England, in 1700 AD the industry was mostly rural and decentralized. The manufacturer was the man, who worked with his own hands in his own cottage. For example, whole of the cloth trade was organised in this system at the beginning of the 20th century.

In the middle of the 18th century, manufacturing was increased and consolidated through mechanization operations and this led to an emergence of the urban industry. The industrial revolution has brought about a major change in the economic and social development. It provided more employment opportunities. As industries grew, the influx of materials like fuel, food, minerals and timber rose sharply into the cities. The new medicines, better control of infectious disease and improved sanitation are success stories of industrial revolution. These new developments have made the human life comfortable with enhanced longevity.

Both these sectors of development have no competition but are complementary to each other. The agriculture output becomes the raw material for industry. For example, cotton is a product of agriculture and raw material of textile industry. It can be concluded that both agriculture and industry are essential for the development and prosperity of a nation.

SOCIAL FACTORS AFFECTING DEVELOPMENT

The development of any nation depends upon economic, political and social factors. Out of these, the social and economic factors are interrelated. The economic development directly depends upon social factors. The main social factors affecting the development are child marriage, child labour, human health, social, cultural and ethical values.

- **Poverty :** It refers to the condition of an individual or a family having insufficient financial resources. Rather they are unable to meet their basic needs in terms of food, cloth, shelter, clean drinking water and required health facilities. The non availability of two square meals a day is an extreme situation of poverty. Out of the six billion people living in the world, one-fifth is below the poverty line. They live in Africa, Latin America and Asia.

Poverty retards the development of a country, as the people living there suffer from chronic malnutrition and most of them never venture to a school. Quite a few of them have access to clean water and much needed medical facilities. They have no security of employment. The people below poverty line are considered burden on the society and government in the developing countries.

The main causes of poverty are factors such as population explosion, unequal distribution of natural resources, non availability of education facilities and employment opportunities. High cost of living becomes another cause of poverty. The governments of many developing countries, including India are spending a sufficient percentage of their annual budget to reduce the poverty and to improve the health of poor people.

- **Affluence :** Affluence means, having lot of money and wealth leading to good standard of living. Accordingly, affluence plays a direct role in the development of a country, as every developmental project require a lot of money. For example, an affluent country has no problem in constructing a dam whereas the developing country cannot think of it due to financial constraints. However, the World Bank comes to the rescue of such nations by providing soft loans to raise the living standard of their people.

• **Education** : It is another social factor that helps in the development of a nation. It increases the mental growth vis-a-vis attitude of the people. They become rather more competent to develop new resources, which definitely contribute towards the economic growth of the nation.

Education makes the people more aware about their personal and national problems. That is why in educated families, the size is restricted to one or two children.

Vocational education and practical training in different fields can be used to tap the vast potential of the people for an overall development and prosperity of a nation.

Education creates a scientific attitude amongst the people. They become open minded with rational approach. It helps them to make intelligent choices after studying the situation in depth.

Education also broadens people's tolerance towards each other and they tend to live harmoniously inspite of different cultures and religions.

• **Employment** : It means to do a job for payment. It is another parameter of judging the development of a nation. Employment is of two types i.e., self employment and wage employment. The employment provide means of livelihood to support a person and his family. The employment not only enchances the prosperity of the employed individual but also increases the prosperity of the nation. Many developing countries are facing an acute problems of unemployment due to increased population and lack of education.

• **Child labour** : One of the main reasons of a bigger family size amongst poor people is their notion that, more the hands to work for the family, the more is their earning. On the ethical basis, the child labour is highly objectionable because this is the age of learning and play. Industrialization has contributed a lot to child labour practices. Children are generally employed on a meagre salary for longer duty hours. The affluent families of the society also employ children in their homes. Many countries now feel concerned about this malady and they have banned child labour. The United Nations has formed an International Labour Organisation (ILO) to monitor the child labour and other about activities.

• **Child marriage**: it refers to the marriage at the young age. It was very common in India about 70 to 80 years back. Even today, it is observed in some communities. In this practice, parents of a young boy select a young girl and they are wedded together. The girl continues to live with her parents. However, when she attains sexual maturity, her in-laws take her to their home. The boy and the girl now start living together to raise their family. Many thinkers like Raja Ram Mohan Roy and Ishwarchandra Vidyasagar thought it to be a curse in the society. They raised their voice and educated the people against such child marriages. Our government has also banned the child marriage. It is now considered as a crime and is punishable. The education has also played its role because the boys and girls themselves avoid the early marriage. As per existing law, a girl can not marry before the age of 18 years.

• **Human health** : In totality, health is a state of complete physical, mental and social well-being. Out of these three parameters, it is difficult to assess social well-being. However, health cannot be delinked from social environment and cultural background. A healthy person can perform his duties efficiently to raise the living standard of his family and this ultimately adds to the prosperity of

a nation. Many developed countries feel concerned about the health of their people as they have now realized that thousands of man hours are lost due to bad health of the employers. It directly affects the development. They are now spending a lot for the good health of their people. On the other hand, in developing countries, due to meagre financial resources, good medical facilities are not available. Poor sanitation, shortage of food and supply of contaminated water have led to the spread of many infectious diseases. People with poor health are unable to play a constructive role in the economic development of their families and their country.

• **HIV/AIDS** : Two most dreadful disease of 20th century are Cancer and AIDS (Acquired Immuno-deficiency Syndrome). Cancer can be curable to some extent but there is no treatment for AIDS as yet. According to an estimate by WHO, there are about 40 million people in the world suffering from this fatal disease. More than three million people die every year from AIDS

AIDS is a viral disease caused by HIV (Human Immuno-deficiency Virus). The first case of AIDS as reported in USA in 1981. In India, the first case was reported in Chennai in 1986. The virus spreads from person to person through sexual contacts, contaminated needles and blood to blood contact. The high risk groups include homosexuals, drug users, recipients of blood and high risk sexual partners. A positive HIV women can pass AIDS virus to her child through her milk or during the pregnancy.

The disease is characterised by reduction in the number of Helper-T cells or CD4 cells which are actively associated with immunity of the body. The body then loses its ability to fight against even minor infections. As there is no cure for AIDS till today that is why most individuals with full blown AIDS die within three years or so. The experts believe that at present prevention is the only mode of controlling AIDS. The government and non-government agencies do educate the people regarding unsafe sexual practice and needle sharing. In our country, government is also doing a lot to control this disease.

• **Social, culture and ethical values** : With the dawn of civilization, human beings settled in different parts of the world. They developed several social, cultural and ethical values duly followed by all the members of that region. These values affect the process of development.

In earlier times, the social values of man were to live in harmony with the environment and his culture. These value were also based on general human ethics. At that time, man considered himself to be the caretaker of nature. He considered it to be his '*dharama*' not to disrupt the peace and degrade the environment. In the present set up, man considers himself to be the ruler of the nature. The degradation of the environment through various unethical practices is quite evident now. Man is hardly replenishing the natural environment.

The cultural values of man in oldest times were based on living in accordance with natural world without disturbing and harming the environment. The present society is purely consumer society. Man has become materialistic that has changed many of his cultural and ethical values. The western culture has shadowed our own cultural values and we have started overexploiting the natural resources.

According to Hindu mythology, "Brahma" created human beings as the custodian of the natural wealth. It is upto man to use it responsibly or irresponsibly. In this contest, the ethical values play a crucial role. It is the duty of every human beings to keep the environment clean and safe not only for

himself but for future generations also. We must consider ourselves as participants and deal with the natural world with utmost responsibility. A society that is built on good social, cultural and ethical values of sincerity, punctuality, gentleness and self-control can provide us peace and contentment.

EXERCISE

(A) Very short answer type questions (1 mark each) :

1. What do you mean by development?
2. Name two factors responsible for spread of infectious disease.
3. What is the main cause of unemployment?
4. Name the international organization that monitors child labour and other labour activities.

(B) Short answer type questions (2 marks each) :

1. What do you understand by health?
2. What is affluence?
3. What are the main causes of poverty?
4. How does the modern agriculture differ from the traditional agriculture?
5. What is agribusiness?
6. How does economic development differ from social development?

(C) Short answer type questions (4 marks each):

1. How does poverty influence the development of a nation?
2. Write a note on role of education in development.
3. What has gone wrong with our cultural, social and ethical values?
4. Write a short note on AIDS.
5. Give a brief account of the factors that led to green revolution.

(D) Long answer type questions: (5 marks each):

1. Discuss child marriage and child labour as social factors affecting development.
2. Explain how agriculture and industry are two major sectors of development.
3. What do you understand by economic and social development?



CHAPTER-5

IMPACT OF LIBERALISATION AND GLOBALISATION

The liberalisation and globalisation have made the world a global village. It is possible by the latest electronic communication systems like mobile phones and satellite phones. One can talk to one nears and dears in a few seconds anywhere in the world. Similarly, many other activities like business and getting medical aid etc. can be handled within few minutes by quick modes of communication.

The internet service is another example of globalisation. Through internet one can get information from any part of the world on any topic as and when required. The doctors can also discuss the condition of their patients with another doctor through internet services.

Due to liberalization, the cultural interaction amongst different countries of the world has increased. The student of our country are going to other developed countries for higher education and for availing job oppurtunities.

The United Nations and members of SAARC (South Asian Assosiation for Regional Cooperation) countries have set up different agencies to help the people of the world against terrorism to provide safe environmet. The issues like conservation of biological diversity are also being addressed under liberalisation and globalisation policies.

LIBERALISATION

It literally means the freedom to live as one wishes without any restrictions from government or any other authority. In the present context, liberalisation refers to economic liberalization and economic reforms started in 1991. India took a major step towards economic reforms and liberalisation through some new policies, as follows:

- Restrictions on foreign investments and Industrial licenses were modified.
- The Foreign Exchange Regulation ACT (FERA) 1973 was modified. The multinationals are allowed to acquire immovable property, employment of foreigners and payment of income earned by them.
- To get import license for trade was abolished.
- Tax administration has been simplified. Tax rates have been reduced on domestic industry as well as on foreign companies.
- Wealth tax has been abolished on the financial assets.
- India has become a member of Multilateral Investment Guarantee Agency (MIGA). As a result, all investments approved by the Government are insured against expropriation.

The policy of liberalization has brought more transparency. The markets are now flooded with latest automobiles, electric gadgets, cosmetics and other consumer items. People have wide range to choose and select their goods. Many multinational companies have set up their production and business units in the developingg countries, including India.

GLOBALISATION

Globalisation is a world-wide exercise that includes the internationalisation of communication trade and economic reforms. The organisations responsible for globalisation are: World Bank International Monetary Fund and World Trade Organisation (WTO). It has created a breakthrough from the rigid national walls to form an international community. In an international community, people share their ideas for an overall welfare of the human society. Globalisation has both positive and negative effects.

The positive effects are:

- There are close ties between government, companies and communities that result in the evolution of free market economy.
- It has brought economic prosperity through buying and selling of products in an international market without any interference.
- For a business man, globalization has brought more market options and better source of profit.

Apart from these positive effects of globalisation, its negative effects are:

- Globalization resulted in great competition and complexity in the trade world. Many of our domestic companies are facing problems and unable to cope with international standards because of lack of qualified labour and financial resources.
- Globalisation has enhanced the living standards of certain population groups, whereas, for the poor and the marginal population it has resulted in creating great economy inequality.
- Spreading of infectious disease, drug trafficking, crime, terrorism and uncontrolled migration are also the byproduct of globalisation.

The impact of liberalisation and globalisation in various sector like agriculture, industry, dislocation of manpower, unemployment and social harmony can be discussed as under:

Impact on agriculture : The modern technology available during liberalisation and globalisation era has helped the agricultural sector towards second green revolution, the first one occurred during 1960's. Some of the benefits of this impact are:

- There is an increase in the production of food grains. The grain production in India increased from 50 metric tones in 1950 to 150 metric tones in 1985. The surplus grains can be sold in open market to earn foreign exchange for the country.
- Due to diversification of agriculture, exotic varieties of vegetables, fruits, orchids, flowers, spices and dry fruits grown by the farmers are likely to create international demand.
- Many food processing and preserving units have come up where vegetables, jams, jelly and juices are preserved for domestic and international market.
- Due to advanced technology, unproductive land has been changed to fertile land. Through drip irrigation method, the sandy soil is also being brought under cultivation.

On one hand, globalisation has brought economic prosperity for the rich farmers and on the other hand, the marginal farmers are sufferers because they do not have facilities to compete globalisation due to financial constraints. Some of the other drawbacks are:

- Most of the chemical fertilizers used in modern agriculture contain micronutrients like potassium, phosphorus and nitrogen. Their excessive use cause deficiency of micronutrients in the soil. For example, in large tracts of high yielding belt of Punjab and Haryana, deficiency of

zinc has caused a decrease in the productivity of the land. The excess fertilizers reach into the soil and contaminate the underground drinking water.

- Various type of pesticides are sprayed upon the crops, food grains, fruits, vegetables and oil seeds to protect them from damage by pests. The non-biodegradable pesticides persist for the long time after their entry into the food chains. Such harmful chemicals enter the human body through fruits, vegetables, grains, milk, meat, eggs, fish products, polluted water, etc. For example, samples of wheat from Delhi, Haryana, Punjab and Mumbai have been found to contain very high level of toxic pesticide residues. These residues cause indigestion, nervous disorders, cancer, etc. in man. Sometimes, instantaneous deaths have been reported due to spraying of these chemicals.

Impact on industries : Globalisation and liberalisation have caused a speedy growth of industries not only in the developed countries, but also in the developing countries, including India. The following data clearly shows the impact on industries:

- Large industries have come up in the different regions. They are involved in mass production of the goods, which is economically more viable.
- Industrial sector has increased the job opportunities that reduce the unemployment.
- Industrial being set up in backward areas, improve the living standard of the people there.
- With the establishment of industries, some other allied businesses like transport and communication have also got developed in backward areas.
- Globalisation has given access to the exchange of latest technology and information amongst different countries, so that developing countries can survive in the international market.
- The fast developing technology has helped the industries to reduce their cost of production and provide more varieties. The industry has now become consumer oriented.
- Agro-based industries have come up near villages to provide agricultural raw material at affordable prices.
- India has created a place for itself in the international market in the field of information technology because of globalization.

There are some negative aspects also"

- Small and cottage industries are closing their business due to uneven play field.
- Environment is being drastically degraded by industrialisation.
- Pollution of land, water, air, noise is increasing day by day.

Dislocation of manpower and unemployment : Globalization no doubt has improved the economic conditions of the society, yet it has also created unemployment and dislocation of manpower. For example, a single automatic machine can do the work of many persons, which results in unemployment. Similarly, in banking industry, a single computer can perform many functions regarding accounts and that is why many banks have started voluntary retirement schemes (VSR) for their employees.

The unemployment leads to dislocation of manpower i.e., they move from one job to another or from one country to another country. A number of skilled and unskilled young people from India are now moving to othe countries to earn their bread and butter. It has created frustration and social unrest in the society.

Impact on social harmony : Like two faces of a coin, globalization can favour or disfavour the social harmony. The positive roles played by globalisation on social harmony are:

- Globalization has provided better medical facilities that reduced infant mortality rate and has increased the life span.
 - Due to globalization, many students in developed countries are coming to India for their education. Similarly, India students are going to the developed countries for higher and specialised education.
 - The multinational companies setting up their units in different countries, including India follow the labour laws strictly. They do not employ child labour. Also they maintain the quality and standards of their products. Above all, they tend to keep the environment clean and healthy.
- Some of the negative effects of globalisation on social harmony are:
- Free access to print media and television has changed the eating habits and life style that has created health problems. It has also brought a drastic change in family bonds due to degradation of social value and traditions.
 - Nuclear families are the result of globalisation as every one wants its own privacy.
 - Due to globalisation, some festivals and other cultural practices have lost their sheen.

Thus it can be concluded that liberalisation and globalisation have created many beneficial impacts, some harmful too.

EXERCISE

(A) Very short answer type questions (1 mark each) :

1. What is globalisation?
2. Name two organisations responsible for globalisation.
3. How does the excessive use of fertilizers contaminate the underground water?

(B) Short answer type questions (2 marks each) :

1. What do you understand by liberalisation?
2. How does globalisation lead to dislocation of man power?
3. Why are the marginal farmers considered as sufferers of globalisation?

(C) Short answer type questions (4 marks each):

1. Make a mention of some economic reforms started by India in 1991.
2. Write a short note on impact of globalisation on social harmony.
3. How do the pesticides influence human health?
4. What are the negative impacts of globalisation on agriculture?

(D) Long answer type questions: (5 marks each):

1. What are the positive and negative impacts of globalisation?
2. Write about the impact of globalisation and liberalisation on industry.
3. Discuss the impact of globalisation and liberalisation on agriculture.



CHAPTER-6

ROLE OF SOCIETY IN DEVELOPMENT AND ENVIRONMENT

The natural resources are rapidly depleting day by day and the environment is getting degraded by human activities. It is not only the duty of the Governments to prevent this degradation. Rather every individual or social institute like non-government organisations, cultural, professional and religious institutions, schools and colleges need to create public awareness about well being of the environment. In democratic country, politicians do support public supported movements positively. Thus when we all are concerned about the environment, the policy makers will certainly make green policies. There is a common proverb that prevention is better than cure, and hence the protection of the environment is economically more viable than cleaning or repairing, once it is damaged.

PUBLIC AWARENESS

For the present purpose, public awareness refers and makes the people conscious about the environment, its degradation and the future consequences. It also advocates environmental protection at all levels. The policy makers will also think and act if there are large numbers of voters, who insist environmental protection. Such awareness can be created through education, eco-clubs and population education programme campaigns.

• **Education** : From the Vedic period, role of the education was to teach a child about his surroundings and his duties toward the protection of its surroundings or environment. Educational institutions such as schools, colleges and universities can play a major role in creating public awareness for the protection of environment. Keeping this in view, the Hon'ble Supreme Court of India has made environmental education, a compulsory subject at the school and college level. In developed nations literate people are very much concerned with their environment and avoid all actions which pollute the environment. In the developing countries, the literacy rate is relatively low that is why they are facing many environment related problems. For example, they do not understand the harm done by the plastic bags. The use of these bags has led to pollution of the environment in many ways.

At the government level, many centers of excellence have been set up to strengthen public awareness and research in different areas of environmental science and management. These include Center of Environment Education (CEE), Ahmedamad; CPR Environment Education Center (CPREEC), Chennai; Center for Ecological Sciences (CES), Bangalore and Center for Mining Environment (CME), Dhanbad since 1986.

The Ministry of Environment and Forests has been organising National Environment Awareness campaign every year. The main aim is to spread the message of environment conservation.

• **Eco-clubs** : Public awareness can be created and executed through Eco-clubs. Such clubs should be formed in all educational institutions, villages, colonies and streets of different cities (Fig. 6.1). Their aim should be to “think globally and act locally” to improve the environment.

Eco-clubs like “Sierra Club” and “National Audubon Society” are already educating the people on various environmental issues. Eco-clubs can undertake the following projects for spreading the message of clean environment :

- (i) They can celebrate days of special environmental significance given below to create environmental awareness.



Fig 6.1. Eco-club spreading message of environmental awareness

TABLE

Sr.No.	Significant Day	Significance of the day
1.	February 2	World Wetland Day
2.	March 21	World Forestry Day
3.	March 22	World Water Day
4.	April 7	World Health Day
5.	April 18	World Heritage Day
6.	April 22	Earth Day
7.	May 22	International Biodiversity Day
8.	June 5	World Environment Day
9.	July 11	World Population Day
10.	September 16	World Ozone Day
11.	September 28	Green Consumer Day
12.	October 03	World Nature Day
13.	October 1 to 7	Wild Life week
14.	October 05	World Habitat Day
15.	December 02	National Pollution Prevention Day
16.	December 03	National Conservation Day

- (ii) With help of the Pollution Control Boards, the International Organisations like Rotary International Organisation, Red Cross and Nationalized Banks, awareness can be created in the fields of biodiversity conservation, habitat preservation, soil, water and energy conservation and disaster preparedness.
- (iii) Discussion and debates on local and national environmental hazards.
- (iv) To undertake exhibitions in different regions on different themes of environment.
- (v) To spread environment protection message through newspapers, radio and television programmes, multi-media CDs, publications, posters and wall charts.
- (vi) To arrange awareness programmes on different issues regarding environment through puppet shows and folk performances.
- (vii) To arrange contests and competitions in educational institutions on environmental issues.
- (viii) To propagate the creation of Biodiversity parks in different locations so that people can see different species, including endangered as well.

• **Population education programme campaign** : The Government of India started an effective Family Planning Programme, renamed as Family Welfare Programme to make the people aware about the dangers of population explosion. Though the slogan '*hum do hamare do*' was given, yet it has not produced desired results and lot remains to be done in this direction. The healthy and family welfare agency of the Government with the help of eco-club, extension workers and other Non-Government Organisation should make the people aware about benefits of small family. The mass media should also inform the people about the family size and ill effects as a growing population on different world resources.

The world is facing a major challenge as to how to fulfill the needs of increasing human population with limited resources. According to a survey, there will be around 48 countries facing paucity of water by 2025. The air will become more polluted. The growing population also adds an enormous amount of waste in the environment. Therefore, the family welfare programme has become rather more important because population growth and the environment are closely linked and dependent upon each other.

PUBLIC PARTICIPATION IN DECISION MAKING

The participation and involvement of general public is very important for the development and environmental protection. With the help of public, it is rather easier to implement any plan or programme related to environment.

At the international level there are so many well known environmental thinkers. Say for instance, Ralph Emerson (1840) long times back spoke about the danger of commerce to our environment. Henry Thoreau (1860) wrote that wilderness should be preserved. John Muir is remembered for saving the great ancient Sequoia trees in California forests, In 1890, he formed the Sierra Club for the conservation of environment in U.S.A.

In India also, there are number of persons who have been instrumental in shaping the environment history in the country. Salim Ali, the Birdman of India was a leading conservation scientist. Mrs.

Indira Gandhi as Prime Minister played a very significant role in the conservation and preservation of India wildlife. Similarly S.P. Godrej was one of the India's greatest supporters of wildlife conservation and nature awareness programmes. He was awarded Padam Bhushan in 1999 because of his conservation activities. Dr. M.S. Swaminathan, the famous agricultural scientist of India is also concerned with various aspects of biodiversity and has laid emphasis on the issue of conservation of biodiversity in India. M.C. Mehta is India's most famous environment lawyer. Since 1984 he has filed good number of public interest litigations for the cause of environmental conservation. His most famous and long drawn battles supported by the Supreme Court include protecting the Taj Mahal and cleaning up the Ganges river. He pressurized the Government to implement environmental education in schools and colleges. Besides these individual conservationists, there are so many examples where people have come forward and showed great concern for the conservation of the environment. Sunder Lal Bahuguna's Chipko movement has become an international example of highly successful conservation action programme with the help of local people to protect their forest resources in the Garhwal region of Uttranchal State. Mr. Bahuguna will always be remembered for his dedication to the environment conservation. In support of this cause he was walked over 20 thousand kilometers. This movement inspired the farmers of Sirsi region of Karnataka where they started the Appiko movement to protest against the felling of forest plants including Teak and Eucalyptus. In Punjab, the best example of public participation is of Sukhomajri village in the Shivalik hills near Sukhna Lake of Chandigarh. Due to deforestation, the hills in this region got denuded and created certain problems for the region. Revegetation of hills and prevention of overgrazing were undertaken by the villagers themselves. This resulted in the dramatic improvement of the region. The soil erosion has stopped and the irrigation needs of the village stand fulfilled. The crop and fodder production too have increased. The availability of fodder led to an increase in milk production. Such an attitude of the people of India as torch bearers will help in making the environment clean and healthy.

Exercise

(A) Very short answer type questions (1 mark each) :

1. Who started the Chipko Movement?
2. Name the ministry associated with environment and forests.
3. Where is the Center for Ecological Sciences located?
4. Where did the farmers start the Appiko Movement?

(B) Short answer type questions (2 marks each) :

1. Name two international environmental thinkers.
2. What was the Chipko Movement?
3. Give two suggestions for creating public awareness.
4. Name two environment related community movements that started in India.

(C) Short answer type questions (4 marks each):

1. Write a short note on role of eco-clubs.
2. How does education play a significant role in creating public awareness about environment?
3. What are the major ill effects of the population explosion?

(D) Long answer type questions: (5 marks each):

1. Highlight the need and role of community participation in development and environmental protection.
2. Discuss some important ways for creating public awareness about environment.



CHAPTER-7

ENVIRONMENTAL POLLUTION

Environmental pollution refers to contamination of the environment with waste products and other impurities. It produces undesirable changes in the physical, chemical or biological quality of air, water and soil. These changes are harmful to human life, other organisms and property. Pollution can be natural or man made. Most of the pollution is man made and is an outcome of different unplanned activities such as urbanization, industrialization, transportation and agriculture. The natural pollution is caused by eruption of volcanoes, weathering of rocks, erosion of soil, forest fires, decomposition of organic matter, etc. The waste products or substances (solids, liquids and gases) that cause the pollution of environment are known as pollutants, e.g., smoke, dust, plastics and pesticides. The important types of pollution are: air pollution, water (fresh and marine) pollution, soil pollution, noise pollution and radiation pollution.

AIR POLLUTION :

The atmosphere is an invisible cover of gases that envelops the earth. The clean air present in the atmosphere is a mixture of gases (nitrogen, oxygen, argon, carbon dioxide) and water vapours. Air pollution refers to contamination of air by waste products and other impurities which are harmful to humans, animals, vegetation and buildings.

The sources responsible for air pollution are of two types viz., the natural sources and the man made sources (Fig. 7.1). The natural sources include forest fires, volcanic eruptions, wind erosion of soil, pollen dispersal, natural radioactivity and decomposition of organic matter by bacteria. The man made sources are much diversified. These include automobiles, industries, thermal power plants, agricultural activities and quarrying. The fossil fuels (coal, oil, natural gas) are burnt in industries, thermal power plants and automobiles. This results in the emission of carbon oxides: carbon monoxide (CO), carbon dioxide (CO₂); sulphur oxides: sulphur dioxide (SO₂), sulphur trioxide (SO₃) and nitrogen oxides: nitric oxide (NO), nitrogen dioxide (NO₂), nitrous oxide (N₂O). Different hydrocarbons (methane, butane, ethylene, benzene) and suspended particulate matter (dust, soot, asbestos, lead, cadmium, chromium, arsenic, salts etc). are also present in these emissions. These gases and suspended particulate matter (SPM) produced as a result of burning of fossil fuels are the greatest source of air pollution. The dust and fumes released by many industries contain nickel, zinc, chlorine, ammonia, hydrochloric acid and oxides of copper. Different types of agricultural activities such as spraying of pesticides, burning of crop residues, release of methane from paddy fields and dust from agricultural operations also cause a minor pollution of air. Quarrying results in the release of a large quantity of dust (coal, limestone, quartz, iron, etc.) into the air.

The pollutants released from natural sources of air pollution are dispersed in a vast area and do not cause any serious damage. Most of the health related air pollutants come from man made sources of air pollution. In large cities, breathing the polluted air proves harmful to human health. Carbon monoxide, a serious air pollutant reduces the oxygen carrying capacity of blood and causes nausea,

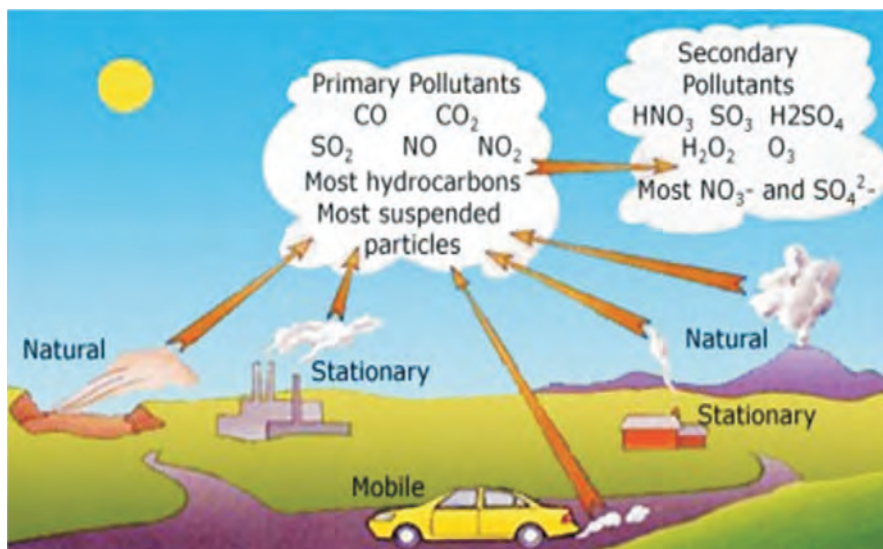

Fig. 7.1 Air Pollution

headache, convulsions, muscular weakness and slurring of speech. Oxides of nitrogen can damage the lungs, heart and kidneys of man and other animals. The presence of hydrocarbons in air causes irritation of eyes, bronchial constrictions, sneezing and coughing. Similarly, Lead can damage liver, kidneys, brain and reproductive system. Different air pollutants can result in stunted growth of plants and even may kill them. In densely populated cities, the air pollution may take the form of industrial smog and photochemical smog. Industrial smog is a combination of smoke, gas and fog. Photochemical smog is produced as a result of interaction of the air pollutants under the influence of sunlight. If it persists for several days, inhalation of this polluted air may cause many health problems. The oxides of sulphur released from different sources react with water vapours present in the air and form sulphuric acid. Then this sulphuric acid falls on the ground as acid rain and results in erosion of buildings, damage to crops and death of aquatic animals. Long term excessive emission of carbon dioxide is also responsible for an increase in the average temperature of the earth's atmosphere. It acts as a green house gas and has significantly contributed to the problem of global warming.

• WATER (FRESH AND MARINE) POLLUTION :

More than 70 percent of the earth's surface is covered with water. Out of this, about 97.5 percent of water is present in oceans. The fresh water which is actually available for irrigation, drinking, power generation and industrial use is only 0.5 percent of the total quantity. It is found in lakes, streams, rivers, and underground. Both the fresh and marine water are very essential for sustaining life on the planet earth. Water pollution may be defined as an undesirable addition of organic, inorganic, biological and radioactive materials into it that deteriorates its true quality.

The major sources of freshwater pollution are sewer system, industries and agricultural farms (Fig. 7.2). The sewage is the waste water containing human wastes (urine and excrement), soaps, detergents, animal wastes and many other dissolved organic compounds. The discharge of untreated sewage into the water bodies results in their pollution. Similarly, the waste generated by different industries such as paper mills, leather tanneries, soap factories and sugar mills also adds to water



Fig 7.2 Water Pollution

pollution. In this industrial waste, a variety of poisonous materials like alkalis, acids, cyanides, lead, mercury, zinc, etc. are key pollutants. Agricultural activities produce several types of water pollutants. The surface run off from the fields carries away the weedicides, pesticides, chemical fertilizers, manures and crop residues into the water bodies. In India, the water pollution is also caused by unburnt and incompletely burnt dead bodies of human beings and other animals that are throw into the rivers.

The pollution of fresh air water makes it unfit for domestic, irrigation, industrial and recreational purposes. Certain micro-organisms present in the polluted water are responsible for spread of several water borne disease such as typhoid, cholera, bacterial dysentary, diarrhoea and heaptitis. Chemicals like lead, mercury and arsenic may damage the nervous system. The pesticides used in the agricultural farms enter the aquatic food-chains and their concentration increases at every stage of the food-chain. This is known as biomagnification. Seepage of these dissolved pesticides may cause pollution of the groundwater. The process of nutrient enrichment (typically phosphates and nitrates) due to entry of fertilizers and detergents in aquatic ecosystems is known as eutrophication. It causes rapid growth of algae and micro-organisms. It decreases the amount of oxygen dissolved in water. The hot water released from an industry into a water source, increases its temperature and thus casuses its thermal pollution. The aquatic biota (animals and plants) that normally live in cool water fail to tolerate this rise in temperature and get killed due to thermal pollution.

The marine water is rich in sea food, salts, chemicals, medicines and minerals. It supports a major components of biological diversity. About one-fifth of the world's total oil supply comes from the sea. Oceans are supposed to be the ultimate disposal sites for all natural and man-made pollution. Like fresh water, marine water also receives a variety of pollutants from different sources. These include surface run off from urban areas and farms, industrial wastes from coastal areas and direct dumping of sewage and garbage by merchant ships and pleasure boats. The accidental oil

spills from tankers, natural oil seepage and materials released from off-shore drilling platforms also cause pollution problems of the marine water. It is more rapid around estuaries, harbours, wetlands and mouths of polluted rivers.

As in case of fresh water, different harmful chemicals dumped into the marine water enter the ocean food-web and undergo biomagnification. The ingestion of pesticides, plastics and other synthetic substances causes death of sea birds and mammals including whales, dolphins and seals. The floating oil released accidentally from tankers and natural oil seepage forms a coat around the body of sea animals which may lead to their death. The pollution of marine water, especially along sea beaches has great economic bearing on coastal area populations. Also, it reduces the recreational value of the beaches vis-a-vis income from fishing and tourism.

SOIL POLLUTION:

The soil is a loose mixture of inorganic minerals (clay, silt and sand), decaying organic matter, water and air. A variety of organisms also inhabit soil for shelter and food. It is formed in nature by disintegrations of rocks. Soil provides different nutrients that are essential for growth of plants. The thickness of this layer ranges from 1m to about 4m. Soil pollution refers to the accumulation of harmful foreign substances like toxic chemicals, pesticides, salts, radio-active waste and disease causing agents that ultimately alter its true fertile nature.

The major pollutants causing soil pollution come from domestic waste, industrial waste and agricultural operations. The domestic waste include kitchen garbage, empty bottles, plastic, cloth pieces etc. that are dumped into the soil. The industrial waste causing soil pollution is generated from paper, textile, petroleum, sugar, cement, leather and chemical plants. Different agrochemicals (herbicides, fungicides, pesticides and fertilizers) used in agriculture deteriorate the natural quality of soil. Heavy rainfall and strong winds also result in loss of the useful topsoil. This phenomenon is known as soil erosion.

Pollution of soil changes its true physical, chemical and biological characteristics. The harmful chemicals added to the soil enter the plants and ultimately find their way into the animal tissues. Many health disorders such as cancer, goitre, arthritis, ulcers, rheumatism, crippled bones and baldness are known to be caused by such chemicals. The poisonous chemicals also kill the useful micro-organisms present in the soil. The seepage of chemicals (fertilizers, pesticides) also leads to pollution of the groundwater. Long term excessive use of fertilizers reduces soil porosity and disturbs its water holding capacity. Such soils become more compact and hence unfit for plant growth. In water logged soils, concentration of salts is very high and these soils are useless and infertile. The pathogens present in the polluted soil cause many soil borne disease in plants and animals. In nutshell, the pollution of soil decreases its fertility and gives rise to many health related problems.

NOISE POLLUTION :

Sound is generated by vibration of air or some other medium. It is known as noise when it becomes too loud or disagreeable. Noise pollution refers to generation of disagreeable loud sound that may pose several health problems. Loudness of sound is measured in decibel (dB). The loudness of normal conversation is about 30-35dB and the average interior loudness of a home is about

45dB. This measurement is approximately 60-70 dB for automobiles and about 120dB for a jet aircraft at take off. Frequency is another characteristic of sound. It is measured in Hertz (Hz) and it denotes the number of vibrations per second. The human ear can perceive sound waves between a frequency range of 20Hz to 20000Hz.

The major sources of noise pollution include industrial plants, motor vehicles, aircrafts, horns, sirens, musical instruments, electrical appliances etc. The use of loudspeaker at religious functions, demonstrations, marriage parties and other social gatherings also causes noise pollution.

Prolonged exposure to noise may cause auditory fatigue and temporary or permanent deafness. Noise interferes with general verbal communication causing annoyance and ill temper. In addition to hearing loss, noise produces physiological disturbances and stress in the human beings. It may cause increase in heart rate, hypertension, peptic ulcers, digestive disorders and brain damage.

• **RADIATION POLLUTION :**

Radiation pollution refers to the emission of harmful radiations from radioactive substances. These substances are unstable and undergo spontaneous breakdown into stable components, releasing energy in the form of radiation. This process is known as radioactive decay. For example, the radioactive nucleus of Uranium (U-235) decays over time into lead (Pb-2007). The radiation emitted by radioactive substances is also called as ionizing radiation as it has enough energy to cause ionization of the atoms it hits. The most common types of ionizing radiation are alpha, beta and gamma radiations.

The natural radioactivity does not pose any serious problem of radiation pollution. Its concentration is very low. The major sources of radiation pollution are the nuclear power plants, radioactive wastes released from these plants and research stations. The nuclear fission taking place during explosion of atom bombs and peace time nuclear experiments results in nuclear fallout. It gives rise to enormous release of high energy radiations. The leakage of radioactive substances from nuclear reactors, industries and laboratories also contribute to the radiation pollution.

The ionizing radiation has several deleterious effects on the living organisms. It can produce changes in the genetic material, i.e. deoxyribo-nucleic acid (DNA). These sudden, relatively stable and inheritable changes in genetic material are known as mutations. Radiation pollution may cause burns on skin, contract, sterility and cancer of bone, thyroid, lung, blood and breast. Radioactive waste may enter the food-chains and becomes dispersed in the ecosystem.

EXERCISE

(A) Very short answer type questions (1 mark each) :

1. What do you mean by environmental pollution?
2. Name different factors responsible for natural pollution.
3. What are the causes of man made pollution?
4. What are important types of pollution?
5. Which are the major gases present in air.

6. Enlist different sources of fresh water.
7. What is biomagnification?
8. What do you mean by eutrophication?
9. Which one is more abundant, marine water or fresh water?
10. Where is the pollution of marine water more rapid?
11. Give the composition of soil.
12. What is soil erosion?
13. How is soil formed in nature?
14. Name the units for loudness and frequency of sound.
15. Give the audible frequency range for human ear.
16. What are mutations?

(B) Short answer type questions (2 marks each) :

1. Differentiate between industrial smog and photochemical smog.
2. How is acid rain produced?
3. What is the harmful effect of excessive emission of CO_2 ?
4. For what purposes do we need fresh water?
5. Define water pollution.
6. How does pollution of underground water take place?
7. What is the cause of thermal pollution?
8. Give major sources of noise pollution.
9. What is radioactive decay? Give an example.

(C) Short answer type questions (4 marks each):

1. How do fossil fuels cause pollution?
2. Give a brief account of sources of marine water pollution.
3. How does the pollution of marine water affect sea animals?
4. Write a note on sources of soil pollution.
5. What are the adverse effects of noise pollution?
6. How does the pollution of soil make it unfit for plant growth?

(D) Long answer type questions: (5 marks each):

1. Explain different sources of air pollution.
2. Describe the adverse effects of air pollution.
3. Discuss briefly the causes and consequences of fresh water pollution.
4. Write an account of soil pollution.
5. What is radiation pollution? Discuss its causes and consequences.



CHAPTER-8

POLLUTANTS AND DISEASES

Pollutants are the substances or agents that cause undesirable changes in the environment, e.g. smoke, carbon monoxide, plastics and pesticides. A great variety of pollutants is generated by varied human activities. Pollutants are of two types, biodegradable and non-biodegradable. Biodegradable pollutants are those, which break into simpler substances by activity of the natural decomposers present in the environment i.e. wood, cloth, paper, faecal matter. On the contrary, non-biodegradable pollutants do not break into simpler substances by the activity of micro-organisms i.e. insecticides, plastics, mercury, lead etc. These pollutants persist in the environment for longer periods. After entering the food-chains, these pollutants may undergo biomagnification. On the basis of their release in the atmosphere, there are two types of pollutants viz., the primary pollutants and the secondary pollutants. The primary pollutants are harmful chemicals that enter directly into the atmosphere, e.g. carbon oxides, nitrogen oxides, sulphur dioxide and hydrocarbons. Secondary pollutants are formed from chemical reactions involving the primary pollutants, e.g. sulphuric acid, ozone and sulphur trioxide. On basis of physical nature, the pollutants can be divided into three categories, solid liquid and gaseous pollutants.

SOLID POLLUTANTS :

The major solid pollutants are as follows:

- (i) **Industrial solid waste :** It includes solid pollutants like construction material wastes, ash generated after burning of coal and wood; wooden pieces of packing material; cotton, woollen and nylon ropes and sheets; pesticides and other toxic chemicals etc.
- (ii) **Domestic solid waste :** It contains solid pollutants such as plastic pieces, polythene bags, broken crockery, leather pieces, rubber pieces, waste paper, empty cans, metal pieces, textiles, food waste etc. (Fig. 8.1)
- (iii) **Agricultural waste :** Agricultural waste produced in farms contains solid pollutants like empty containers of pesticides, belt pieces, rope pieces, plastics, crop residues, cow dung, fertilizers etc.



Fig. 8.1. Domestic Solid Waste

- (iv) **Hospital waste :** It includes empty glass and plastic bottles, discarded syringes, waste cotton, discarded instruments, bandages, expired medicines etc.
- (v) **Quarrying :** This operation also generates enormous quantity of solid pollutants in the form of metallic ores, earthen material, rock dust etc.

LIQUID POLLUTANTS :

The important liquid pollutants are as follow :

- (i) **Industrial pollutants:** The liquid waste released from industrial plants contains chemical pollutants such as chlorides, sulphides, zinc, lead, mercury, arsenic, boron, acids, alkalis, radioactive wastes, pesticides and othe toxic chemicals.
- (ii) **Domestic pollutants :** The waste water of the domestic sewage contains liquid pollutants like human faecal matter, soaps, detergents, disinfectants etc.
- (iii) **Agriculture pollutants :** The surface run off from agricultural fields carries away liquid pollutants such as fungicides, weedicides, pesticides and fertilizers.
- (iv) **Oil spillage :** The oil released from natural seepage, tanker accidents, off shore drilling platforms, refineries and wastes from industries, transportation and agriculture is another important liquid pollutant responsible for pollution of water.

GASEOUS POLLUTANTS :

These pollutants may be released in the form of primary pollutants that are directly released into the atmosphere from their natural or man made sources or may be produced in the atmosphere by chemical interaction of primary pollutant with other air pollutants or natural components of the air. The major gaseous pollutants include oxides of carbon: carbon monoxide (CO) and carbon dioxide (CO₂); oxides of sulphur : sulphur dioxide (SO₂) and sulphur trioxide (SO₃); oxides of nitrogen: nitric oxide (NO), nitrogen dioxide (NO₂). The other gaseous pollutants are methane and other hydrocarbons, suspended particulate matter (SPM), chlorofluorocarbons, industrial and photochemical smog. A majority of these gaseous pollutants are generated as a result of burning of fossil fuels in industries and automobiles (Fig 8.2). Chlorofluorocarbons are released from air-conditioners and refrigerators in which these are used as coolants.



Fig. 8.2. Gaseous Pollutants

POLLUTION RELATED DISEASE

The environmental pollution has numerous harmful effects on human health. Different types of pollutants present in air, water and soil pose serious threats to quality of environment and result in critical disease and health disorders. According to World Health Organization (WHO), as much as 23 percent of the global burden of disease is associated with environmental pollution. Depending upon the economic growth, social development, climatic conditions and geographical location, the magnitude of these health problems varies in different nations. People in the poor countries are more susceptible to the ill effects of environmental pollution. Different pollution related disease are briefly discussed below:

AIR POLLUTION RELATED DISEASE :

The air pollution causes death of about three million people every year. Despite the fact that human respiratory system has sufficient defence mechanisms, the prolonged exposure to air pollutants may induce several disease and disorders. These diseases and disorders include chronic bronchitis, emphysema, lung cancer, asbestosis, silicosis, dizziness, headache, eye irritation, sore throat, shortening of breath etc. Chronic bronchitis results from long term exposure of respiratory tract to the air pollutants such as ozone, sulphur dioxide, nitrogen dioxide and particulate matter. The excessive secretion of mucus blocks the air passage. The muscles associated with respiratory tract become weak due to prolonged coughing. In patients suffering emphysema, the alveoli of lungs lose their capacity to expand and contract. This reduces the respiratory surface for gaseous exchange in lungs and the patient may die of suffocation or heart failure. Radioactive pollutants and particulate matter especially the particles of asbestos, beryllium, chromium, arsenic and nickel stimulate abnormal growth of the mucous membranes which may lead to severe lung cancer. Asbestos fibres and quartz dust generated during mining operations causes asbestosis and silicosis respectively. The victims of these disease suffer from coughing and shortness of breath. The smog produced by combination of smoke, gas and fog causes respiratory disorders like asthma and allergies.

WATER POLLUTION RELATED DISEASES :

The polluted water harbours a variety of disease causing agents such as bacteria, viruses, protozoa and parasitic worms. Discharge of untreated sewage into water bodies in the major sources of these pathogens. Such organisms are responsible for spread of several water borne disease. These include typhoid, cholera, bacterial dysentery, enteritis, hepatitis, jaundice, polio, amoebic dysentery and schistosomiasis. Consumption of contaminated water for drinking purpose results in spread of these disease. The standing water provides favourable breeding grounds for mosquitoes which act as vectors for transmission of dangerous diseases like malaria, filaria and dengue. Different heavy metals present in polluted water also cause serious health problems. Consumption of water contaminated with mercury compounds leads to numbness of limbs, lips and tongue, deafness, mental retardation and blurring of vision. Similarly, cadmium can cause itai-itai disease, a painful disease of bones and joints.

SOME DISEASE RELATED TO WATER POLLUTION

Causative Agent	Disease	Effects
Bacteria	Typhoid	Diarrhoea, vomiting, enlarged spleen, inflammation of intestine
	Cholera	Diarrhoea, vomiting, dehydration
	Bacterial dysentery	Diarrhoea
	Enteritis	Severe stomach pain, nausea, vomiting
Viruses	Infectious hepatitis	Fever, headache, loss of appetite, abdominal pain, jaundice, enlargement of liver
	Polio	High fever, headache, sore throat, stiffness of neck, muscular pain, severe weakness, tremors, paralysis
Protozoa	Amoebic dysentery	Diarrhoea, headache, abdominal pain, chills, fever, liver abscess
Parasitic Worms	Schistosomiasis	Abdominal pain, skin rash, anaemia, chronic fatigue ill health

The excessive amount of fluorides present in drinking water cause teeth deformities hardening of bones and painful joints. Every year, more than five million people die from diarrhoeal disease caused by consumption of polluted water. Pesticides such as dichloro-diphenyl-trichloroethane (DDT), dieldrin, mirex and aldrin added to the water sources can induce cancer tumourous growths, chromosomal aberrations and brain damage.

SOIL, RADIATION AND NOISE POLLUTION RELATED DISEASE : The intestinal parasites present in the polluted soil cause serious infections to man and his domestic animals. The radiation pollution can induce abrupt changes in the genetic material of different animals, including man. Long term exposure to ionizing radiation triggers the development of cancer in body tissues. Noise pollution may cause temporary or permanent deafness, peptic ulcers and damage to brain.

HANDLING AND MANAGEMENT OR HAZARDOUS WASTES

The hazardous materials are those substances or preparations that can cause harm to human health or the environment, when improperly treated, stored, transported or disposed off. Similarly, any discarded material that threatens human health or environment is known as hazardous waste. These wastes or substances may be in solid, liquid or gas form. Hazardous substances and wastes include a variety of acids, dioxins, abandoned chemical, infectious hospital wastes, heavy metals, organic solvents, polychlorinated biphenyls (PCBs), pesticides and radioactive substances. These chemicals are dangerously reactive, explosive, poisonous or corrosive in nature. There are numerous such substances from the nuclear power plants, pesticides manufacturing plants, defense research

laboratories, university research laboratories, big hospitals and military bases are the most important sites where the hazardous substances, hazardous wastes and associated processes are handled.

In the past, a number of tragedies had occurred due to improper handling and processing of these substances. The worst nuclear accident occurred at Chernobyl plant in the former Soviet Union on April 26, 1986. In this accident, the explosion destroyed the reactor and released large quantities of radioactive material into the atmosphere. In 1984, the world's worst industrial accident occurred at Union Carbide pesticide plant in Bhopal, India. Methyl isocyanate, a hazardous substance used in preparation of pesticides leaked from the storage tank and killed more than 2300 people, About 1400 people suffered from blindness, sterility, tuberculosis, liver infections, kidney infections and brain damage. These tragedies highlight the need of adopting proper safety measures while handling hazardous substances and wastes.

These are three basic ways to manage the hazardous waste:

(i) Reduction in quantity : The most effective way to manage the hazardous waste is to reduce the total amount of waste produced. This can be done by adopting better industrial processes that reduce the quantity of hazardous waste. The reuse or recycling of the hazardous waste also reduces the total quantity of the waste. The hazardous waste produced by one industrial firm can also be used as raw material by other industrial unit.

(ii) Conversion to less hazardous materials : Conversion of more hazardous waste to less hazardous waste is helpful in reducing its toxicity. This can be done by physical, chemical or biological treatment of the hazardous waste. The physical treatment of hazardous waste involves physical processes like sedimentation, screening, floatation, centrifugation, evaporation etc. The chemical treatment includes neutralization, precipitation, absorption etc. The biological treatment of hazardous waste makes use of micro-organisms for decomposition of more hazardous waste into less hazardous substances. Another important method to detoxify hazardous waste is incineration. It involves burning of hazardous waste at high temperature under controlled conditions. The combustion of high temperature in the incinerators reduces the toxic wastes to less hazardous ash. The plasma torches are capable of producing temperature greater than 10000°C and convert the hazardous wastes to harmless ashes. Although incineration is an excellent method for treatment of solid hazardous waste but it is quite expensive. In India, incinerators are used for treatment of hazardous wastes from the hospitals.

(iii) Long-term storage: The third way for management of hazardous waste is its long-term storage in specially designed pits known as landfills. The site for construction of a landfill is very carefully selected. It is geologically stable and safe from earthquakes and floods. At the bottom of the landfill, compact layers of clay and plastic are present. This prevents the percolation of hazardous waste into groundwater. The hazardous waste is filled in sealed containers and stored in the landfills. Then these landfills are covered with soil. It is being emphasized that the dangerous nuclear radioactive waste should be deposited deep under ground in rocks.

EXERCISE

(A) Very short answer type questions (1 mark each) :

1. What are pollutants?
2. Name three different types of pollutants on the basis of physical nature.
3. Make a list of solid pollutants present in the hospital waste.
4. Give the sources of chlorofluorocarbons.
5. What is the cause of chronic bronchitis?
6. How is smog produced?
7. Name different disease causing agents.
8. How does noise pollution affect human health?
9. Name the chemical associated with Bhopal gas tragedy?

(B) Short answer type questions (2 marks each) :

1. What are pollutants?
2. How are secondary pollutants formed?
3. Enlist different solid pollutants present in the domestic solid waste.
4. Give different oxides of nitrogen and sulphur.
5. How does polluted standing water harm human life?
6. Name different physical processes used for treatment of hazardous wastes.

(C) Short answer type questions (4 marks each):

1. Differentiate between biodegradable and non-biodegradable pollutants.
2. Give a brief account of different liquid pollutants.
3. Write a short note on hazardous substances.
4. How does incineration help in management of hazardous wastes?

(D) Long answer type questions: (5 marks each):

1. Discuss different types of solid pollutants.
2. Describe briefly the disease and disorders caused by air pollution.
3. Describe the adverse effects of polluted water on human health.
4. Discuss different ways for management of hazardous wastes .



CHAPTER-9

GLOBAL ISSUES AND IMPROVEMENT OF ENVIRONMENT

The rapid degradation of the environment due to pollution has led to several global issues facing the modern world. These global issues include depletion of ozone layer, global warming, protection of water sources, protection of land sources, conservation of biological diversity, management of hazardous chemicals and protection of human health. The first two important global issues are discussed here in this chapter.

OZONE LAYER DEPLETION AND ITS EFFECTS

The atmosphere is a gaseous envelope surrounding the planet earth. It is divided into five zones, the troposphere, stratosphere, mesosphere, thermosphere and exosphere. The troposphere is closest to the earth's surface and extends upto a height of 10km. The next division of the atmosphere, the stratosphere, extending from 10km to 45km above the earth's surface, contains a layer of ozone. This ozone layer acts as a filter to prevent the entry of excessive amount of harmful ultraviolet radiation into the atmosphere. In this way, it serves as a life saving protective cover for all the life forms and helps in maintaining relatively stable climatic conditions. Chemically, ozone is a bluish gas and one molecule of ozone consists of three atoms of oxygen. The problem of ozone layer depletion was first noticed over Antarctica in 1985. This ozone hole was investigated with the help of highflying aircrafts and a high concentration of chlorine was recorded in the upper atmosphere. It was concluded that the chlorine had reacted with ozone and created this hole in the ozone layer. In 1992, a relatively smaller hole in the ozone layer over the Arctic was also detected.

The most important cause of depletion of ozone layer is a group of chemicals known as chlorofluorocarbons (CFCs). These are commercially important chemicals and are used as coolants in air conditioners and refrigerators, as propellants in aerosol cans, as foam for insulation and packaging and as medical sterilizers. In addition to chlorofluorocarbons, halons found in many fire extinguishers; methyl bromide, used as a fumigant in agriculture; methyl chloroform, used to degrease metals, and carbon tetrachloride used in manufacture of pesticides and dyes, also deplete the ozone layer. Under action of ultraviolet radiation, these chemicals breakdown to release free chlorine atoms. This chlorine then attacks the ozone and converts it into oxygen. As the chlorine atom itself remains unchanged, a single chlorine atom is capable of breaking thousands of ozone molecules. In this way, the ozone layer is being depleted by chlorine freed from these chemicals.

The depletion of ozone layer would allow more amount of ultraviolet radiation to reach earth's surface. The excessive exposure to these harmful radiations may cause serious health problems in

human beings. These include eye cataracts, suppression of immune system, skin cancer and severe sun burns. The increased amount of ultraviolet radiation is harmful to other living organisms too. It may effect the growth and yield of food crops such as corn, rice and wheat. The phytoplankton present in the aquatic ecosystems is very essential for survival of different aquatic food-chains. It has been scientifically discovered that the increased exposure to ultraviolet radiation has reduced the amount of phytoplankton population in surface waters around Antarctica. If this trend continues, the food-chain of Antarctica which includes fishes, seals, penguins, whales and sea birds will be adversely affected and may disappear in future.

In view of the potential economic, health and environmental concerns, the problems of depletion of ozone layer has emerged as a global issue facing the modern world. Since 1978, the United States has completely banned the use of CFCs as propellants in products such as hair sprays and antiperspirants. The Montreal Protocol, 1987 is an important international initiative to mitigate this climatic changes. More than 175 countries, including India have signed this agreement till-date. The agreement aims at reducing the amount of CFCs being used by different nations. Unfortunately, the CFCs are extremely stable chemicals and will continue to deplete the ozone layer for years to come. Attempts are also being made to find the suitable alternatives for CFCs.

GREEN HOUSE EFFECT AND GLOBAL WARMING

The term green house refers to a framed or inflated structure covered with a transparent or translucent material. It is used for growing plants under controlled environment. The visible light from the sun penetrates the transparent material of the green house and warms the ground surface and other objects placed inside. The heated surface and objects then emit heat in the form of invisible infra-red radiation. This heat or infra-red radiations cannot pass back through the glass of the green house and are trapped inside. As a result of the warming effect so produced, the temperature inside the green house increases and it is much higher than the air outside.

The atmosphere surrounding the earth is like a large green house. Carbon dioxide, water vapours, ozone, methane, nitrous oxide and CFCs present in the atmosphere absorb the infra-red radiations and act like the glass of a green house. This prevents the escape of infra-red radiations back into the space. The resulting trend of gradual increase in the average temperature of the earth's atmosphere due to accumulation of green house gases is termed as global warming.

The long term emission of carbon dioxide since industrial revolution, alone has made 50-70 percent contribution to the problem of global warming. Its global amount has increased by more than 26 percent in the past 200 years. This increase is primarily due to burning of fossil fuels, especially coal and oil in industries, thermal power plants, automobile; deforestation and increased human population. If the present rate of fossil fuel consumption and deforestation continues, it is estimated that the amount of carbon dioxide will become double by the end of 21st century. The levels of other green house gases such as ozone, methane, CFCs and nitrous oxide produced from different sources are also rising at an alarming rate.

Major greenhouse gases

Green house Gases	Sources
Carbon dioxide (CO ₂)	From burning of fossil fuels (coal, oil, natural gas) and deforestation
Chlorofluorocarbons (CFCs)	From air conditioners, refrigerators, hair sprays, anti perspirants.
Methane (CH ₄)	From wetlands, rice fields, animal waste, gut of ruminants
Ozone (O ₃)	From air pollution (trapped in photochemical smog)
Nitrous oxide (N ₂ O)	From fertilizers and burning of coal and oil

EFFECTS OF GLOBAL WARMING

The probable impact of global warming is much diversified. The average global temperature would be increased due to global warming. This increase in temperature will result in melting of polar ice sheets and it will raise the sea level. There exists a possibility that the sea level may rise 18cm by 2030 and 58cm by 2090. This will result in flooding of low lying coastal areas. In this way, millions of people will be displaced. There will be more chances of damage by hurricanes and typhoons in these areas. The countries such as Bangladesh, Egypt, Vietnam and Mozambique are most vulnerable to such risks arising due to rise in sea level. Global warming is also expected to change the rainfall distribution pattern of the world. There may be an increase or decrease in rainfall in different areas. The arid and semi-arid areas may have to face severe shortage of water. The frequency and intensity of storms may also increase. The climatic changes due to global warming will pose several problems for the agriculture. The flooding of coastal areas will destroy the vast stretches of agricultural low lands and deltas in Bangladesh, India and China. The changes rainfall pattern would effect the crop yield and food production. It may increase in some areas while there will be a decline in crop yield and food production in some other areas. The warmer climatic conditions would enhance insect breeding and there could be more damage expected to crops from different insect pests. Several crop disease causing organisms will probably proliferate and damage the crops. The increased frequency of droughts may generate water scarcity for cultivation of different crops.

Several possible effects of global warming on animals and plants have been predicted by scientists. Global warming will have a severe impact on plants because they cannot migrate directly to new areas. Their migration takes place by dispersal of seeds. The animal life inhabiting wetlands, coral reefs, polar seas, temperate forests and mountain ecosystems is likely to be affected by global warming. The change in global temperature will influence different animal species in different ways. Some of the species having a narrow temperature tolerance range will become extinct and the others will be reduced in number. Some species may be able to get adapted to new climatic conditions in their native places or they will migrate to other areas for survival. It is expected that disease causing

organisms, insect pests of different crops and weeds will be benefited from the global warming. These harmful organisms will further enhance the health problems for man, animals and crops. All these probable effects of global warming indicate that the climatic changes will have serious implications on human society, agriculture and living organisms.

STRATEGIES FOR REDUCING POLLUTION AND IMPROVING ENVIRONMENT

During the past century, the population explosion, industrialization, urbanization, extensive agriculture, transportation and deforestation have done a serious damage to the quality of our environment. The pollution of air, water and soil, depletion of ozone layer, global warming, conservation of biological diversity, management of hazardous wastes and protection of human health have emerged as major challenges to the modern world. These issues must be attended by devising appropriate strategies and hence finding constructive solutions to improve the quality of the environment. The important strategies for reducing pollution and improving the environment are discussed here:

- (i) **Disposal and treatment of wastes :** The industrial, domestic and agricultural wastes are major sources of environmental pollution. Appropriate waste disposal and treatment techniques can reduce the pollution to a considerable extent. Many substances such as paper, plastic, glass, metal etc. present in the solid waste may be separated and recycled. In this technique the used items are collected, remelted and reprocessed into new products. Recycling reduces the total amount of solid waste and also generates employment opportunities for the people. The solid and liquid wastes can be neutralized and detoxified by a number of physical, chemical and biological processes. These friendly techniques reduce the volume and toxicity of different wastes. Some commonly followed physical processes are sedimentation, filtration, evaporation, floatation, screening etc. Chemical treatment includes neutralization of acids and alkalis, precipitation and absorption or activated charcoal, In biological treatment or bioremediation, the hazardous waste is exposed to the action of micro-organisms. These friendly bacteria convert the harmful waste into harmless or less harmful substances. In addition to proper treatment, the disposal of wastes at relatively safer and stable sites also reduces environmental pollution.
- (ii) **Organic farming :** Excessive use of chemical fertilizers, pesticides, herbicides, and fumigants causes severe pollution of air, water and soil. Continued use of inorganic fertilizers has deteriorated the natural conditions of the soil. In this regard, organic farming is an ecofriendly approach aimed at improving soil conditions and reducing pollution. Following this technique, the crops are grown without the use of synthetic fertilizers and pesticides. Instead of using inorganic synthetic fertilizers, organic farming involves use of farm yard manure, compost, vermicompost and biofertilizers. Compost can be prepared from weeds, paper, food wastes, leaf litter, branches and cattle dung, This also solves the problem of management of solid waste. Now-a-days, different species of earthworms are being utilized to prepare vermicompost

from organic wastes including leaf litter, crop residues, food waste and cattle dung (Fig 9.1.) Biofertilizers are, useful blue green algae and bacteria which live in soil and provide nutrients to the crops. They are environmentally safe. The worldwide demand for organically produced crops is increasing every year.



Fig. 9.1. Vermicompost

- (iii) **Insect pest control :** Many species of insects cause damage to different crops and result in great economic losses. Different commercial crops such as wheat, rice, sugarcane, maize, cotton, potatoes etc. are attacked by numerous insect pests. In order to minimize the yield loss, a wide range of synthetic chemicals are applied to control the pest populations. The excessive use of chemical methods leads to environmental pollution, besides the problem of resistance to pesticides. These harmful effects have forced man to think about alternative means of insect pest control. Integrated Pest Management (IPM) is one such strategy. It makes the use of all different methods in an integrated fashion. The basic purpose of IPM is to reduce the use of chemicals, Biological control is a method of controlling insect pests by their natural enemies. Both these methods reduce the use of pesticides and hence are ecofriendly.
- (iv) **Afforestation :** Forest are very essential for maintaining ecological balance and stable climatic conditions. It is quite unfortunate that the world's forests are disappearing at an alarming rate of 16.9 million hectare every year. Afforestation is the best solution to combat this loss (Fig. 9.2.). It refers to the growing of more forest with an aim to protect and improve the



Fig 9.2. Afforestation

environment. In addition to protection of the environment, the afforestation also meets the needs of the public. In India, only about 19.27 percent of the total geographical area is under forest cover and there exists an urgent need for afforestation.

- (v) **Technological upgradation :** Attempts are also being made to develop better techniques and equipments for reducing environmental particulate. The electrostatic precipitators, cyclone filters and wet scrubbers can be used to remove the particulate matter from the gaseous waste produced by industries, before releasing it into the atmosphere. Similarly, the use of catalytic converters in automobiles can minimize the emission of carbon monoxide. Every year, thousands of incompletely burnt dead bodies are dumped into the Ganges and other rivers in India. The use of electric crematoria can prove very helpful in reducing the pollution of river waters caused by decomposition of these bodies. A number of transgenic crop varieties have been developed through the techniques of genetic engineering. These varieties are resistant to attack by different pests. After making a proper assessment of benefits and risks, these transgenic crop varieties can be grown for use as food, fodder and pharmaceuticals. The use of alternatives is also helpful in ensuring safe environment. The hydrochlorofluorocarbons (HCFCs) are less dangerous than chlorofluorocarbons (CFCs). The use of compressed natural gas (CNG) in motor vehicles causes less air pollution than diesel fuel. Efforts are being made to develop efficient technology for harnessing solar and wind energy. The advanced techniques and instruments can reduce the environmental risks associated with the hazardous wastes.
- (vi) **International efforts and legislation :** Different international conference recommendations and agreements are of great importance in raising a global concern about betterment of the environment by different nations. In this regard, the United Nations Conference on Human Environment, convened at Stockholm in June 1972 was the first serious international effort. It invited attention of people and governments towards the global recommendation for well being of the human environment. A long term international programme known as United Nations Environment Programme (UNEP) was started for protection of the environment. Montreal Protocol, 1987 is an important international agreement to minimize the amount of chlorofluorocarbons (CFCs) being used by different countries. More than 175 countries, including India have signed this agreement till date. In the first Earth Summit, 1992 held at Rio de Janeiro, Brazil, the global issues of pollution, deforestation and declining biological diversity were addressed and a need for sustainable development was emphasized. Several laws have been enacted by different nations for reducing pollution and protecting environment. As legal measures in India, different acts relating to environment have been enacted from time to time. Some important Acts are, the Forest Act, 1927; the Insecticides Act, 1968; The Forest Conservation Act, 1980; the Wildlife (Protection) Act, 1972; the Water (Prevention and Control of Pollution) Act, 1974; the Air (Prevention and Control of Pollution) Act, 1981, the Environment (Protection) Act, 1986 and the Biological Diversity Act, 2003.

- (vii) **Environmental awareness** : In addition to the above discussed efforts, the public awareness and community participation is a must for improvement and protection of the environment. In this concern, a number of international and national Non-Government Organizations (NGOs), clubs and societies are playing a significant role. More and more people are being made aware of the environmental issues. The ecological awareness is helpful in reviving the traditional approach towards ecology, nature, water resources and wildlife in the minds of people.

EXERCISE

(A) Very short answer type questions (1 mark each) :

1. What are atmosphere?
2. How many zones are there in the atmosphere?
3. In which zone of the atmosphere, the ozone layer is present?
4. When was the depletion of ozone layer first discovered ?
5. What is a green house?
6. What is the technique of recycling?
7. Which animal is used for preparing vermicompost?
8. What is a crop pest?
9. What is afforestation?

(B) Short answer type questions (2 marks each) :

1. What are different global issues facing the modern world?
2. How does the ozone layer protect the life on earth?
3. What are chlorofluorocarbons?
4. What are green house gases?
5. How will the global warming change the sea level?
6. What is bioremediation?
7. What are biofertilizers?
8. What is green house effect?

(C) Short answer type questions (4 marks each):

1. How do the CFCs damage the ozone layer?
2. How is the green house effect produced?
3. What do you understand by global warming?
4. Write about the role of carbon dioxide as a green house gas.
5. How can we minimize the use of pesticides and synthetic fertilizers?

(D) Long answer type questions: (5 marks each):

1. Write about the adverse effects of ozone layer depletion. What steps have been taken to mitigate this climatic change?
2. What is the probable impact of green house effect on agriculture, animals and plants?
3. Discuss organic farming and IPM as strategies for reducing pollution.
4. Comment upon the role of technological upgradation and public awareness for improving environment.



CHAPTER-10

DISASTERS

The word disaster has been derived from the French word '*desastre*' which means a bad or evil star. Disaster is a sudden event that causes a great damage to human life, plants, animals and property. According to the World Health Organization (WHO), disaster is an occurrence that causes economic destruction, loss of human life, deterioration of health and health services on a scale sufficient to elicit an extraordinary response from the people outside the affected community in the area. The recent disasters faced by the modern industrialized world are of greater magnitude and more devastating than those occurred in the past. Disasters are of two types, the natural disasters and the man made disasters.

NATURAL DISASTERS

Natural disasters happen due to certain natural causes or forces. These include earthquakes, droughts, floods, cyclones and landslides. The natural forces responsible for these disasters are beyond man's control. The important natural disasters are briefly explained here :

- **EARTHQUAKE** : Any sudden violent shaking or trembling of the earth's crust due to a natural cause is known as an earthquake. It is one of the most terrifying natural disasters that cause great loss of life and property. The energy associated with a single major earthquake may be more than several thousand atom bombs. The major natural cause responsible for earthquake is movement of molten rocks present beneath the earth surface. This results in sudden slipping of the portions of earth's crust past each other, producing strong vibrations. The place of origin of these vibrations within the earth is known as seismic focus. The point on earth's surface exactly above the centre of seismic focus is known as epicentre of the earthquake. The strength of an earthquake is measured by the Richter Scale which ranges from 0 to 8. Eruption of volcanoes is another cause of earthquakes. Underground nuclear tests also generate minor earthquakes. The strength of vibrations can be measured by using an instrument known as seismograph. Earthquakes cause tremendous damage to life and property. The Assam earthquake of June 12, 1897 was one of the most terrifying earthquake of the world. In 1935, the Quetta earthquake caused more than 25000 death. The earthquake of Bhuj and Ahmedabad in Gujarat on January 26, 2001 destroyed 8 lakh houses killing 20000 to 30000 people. More recently, the earthquake of October 10, 2005 has caused death of more than 40000 people in Pakistan. The tremors during an earthquake result in collapse of mud and brick houses, twisting of railway lines, out breaking of fire and damage to underground water supply system. Earthquakes also cause landslides in mountainous regions. Strong tsunami waves are generated by earthquakes, which have their origin in the oceans.

The causes responsible for earthquakes are beyond control of man. However, the damage caused by earthquakes can be mitigated. It has been observed that the performance of man made buildings, electric and water supply lines is very poor during the earthquakes. This is primarily due

to faulty structural designs, lack of symmetry and poor quality of construction material. This can be avoided by adopting proper structural designs. The participation of community and Non-Government Organizations (NGOs) is very essential in different earthquake mitigation programmes. In addition to technological skills, the disaster preparedness also involves awareness and consciousness among masses, Better communication facilities, rescue operations and accurate planning can minimize the losses during earthquakes.

• **DROUGHTS** : It can be defined as a drying up condition of land due to unusual scarcity of water in an area, where a normal rainfall is expected. A drought may last for from a few days to many years. During the drought period, the different water reservoirs dry up. The conditions of the weather remain dry for long period. More severe droughts generally occur in the regions between latitudes of 15°-20°. In India, the states of Rajasthan, Gujarat, Tamilnadu, Jharkhand, Chhattisgarh, Karnataka and Maharashtra are drought prone areas. Changing rainfall patterns due to global warming, deforestation, industrialization etc. are contributing towards this natural disaster.

Dry conditions of land during the drought period destroy the fertile topsoil rendering it useless for cultivation. This is known as desertification of land. The acute shortage of water, food and fodder causes starvation and death of animals and human beings. Drought also causes soil erosion, famine, health problems and unemployment.

Conservation of water is very essential to mitigate the harmful effects of drought. This can be achieved through rainwater harvesting and canal irrigation systems. Emergency water storage tanks should be constructed. The practice of sowing drought resistant crop varieties following improved agricultural methods can prove helpful in coping with dry weather conditions. Plantation of more and more trees in the drought prone areas helps in percolation of the rainwater under ground. The people in drought-hit areas should be provided with emergency water supply and adequate resources.

• **FLOODS** : A flood refers to the inundation of a large land area for several days. It is the



Fig. 10.1 Floods as natural disaster

most frequent natural disaster that has been destroying and damaging human life and property since times immemorial. Floods are commonly due to excessive rains in a particular area. The other causes of floods include bursting of dams and sudden release of pent up waters of a river choked by landslides. Earthquakes occurring in oceans beds also generate serious flash floods in the coastal areas. Many a times, natural bursting of clouds in mountainous regions also results in flash floods. Anthropogenic activities such as deforestation, changes in land use pattern, agricultural practices, construction of bridges etc. also intensify the magnitude of the disaster. In India, the Himalayan rivers like the Ganges, the Brahmaputra, the Satluj etc. are responsible for 70 percent of the flood damages (Fig. 10.1). In many Indian states such as Assam, Bihar and West Bengal, floods are a routine affair every year during the monsoon season.

Floods causes huge loss of life and property. Thousands of people are displaced and become homeless. Floods destroy the agricultural field leading to shortage of food and fodder. The telephone service, water supply, electricity supply and transportation are badly hit and get interrupted. The natural habitats of different wild animals are destroyed. This leads to death or migration of these animals. The erosion of upper fertile layer of soil also takes place. After the floods, many infectious diseases may spread in the flood affected areas. The weather forecast made on the basis of data collected by meteorological department seems to be useful in mitigating this natural disaster. On basis of these warnings, the people can move to safe areas before the disaster occurs. The construction of check dams or water reservoirs and afforestation help in reducing floods. It is quite unfortunate that our wetlands are shrinking at a rapid rate. The restoration of these wetlands can partially play a significant role in control of floods. The timely public health services can prevent the chances of an epidemic outbreak after the floods. The Governmental efforts coupled with community participation can minimize the losses caused by floods.

• **CYCLONES** : Cyclones are low pressure systems that develop over the surface of oceans in tropical and subtropical regions. These are known as hurricanes in West Indies, willy-willies in from 50 km to 300 km. The pressure in the centre of the cyclone is quite low and fast winds blow in a spiral manner around it. The wind speed in a cyclone may be 120 km per hour. In India, the cyclones develop over the surface of the Arabian Sea and the Bay of Bengal Cyclones follow the direction of regular wind and strike suddenly. They generally remain active on surface of oceans. After leaving the ocean surface, they loose their strength. When a cyclone approaches an area, the sky becomes dull and over clouded. There is heavy rain, thunder and lightening.

Cyclones cause great damage to human life, crops, general vegetation and buildings. The strong winds uproot trees and lift roofs of houses. Heavy rains brought by a cyclone may cause flooding of an area and subsequent spread of infectious diseases. Cyclones also damage ships and other installations in the coastal areas. In India, cyclones are an annual feature, occurring mostly in October and November. The Orissa cyclone of 1999 caused huge damage to property and loss of more than 10000 human lives.

Development of cyclones over ocean surface is beyond our control. But unlike earthquakes, the

approach of cyclones to an area can be predicted through different techniques. Weather sensing satellites are used for this purpose. These are also helpful in evacuating people to safer areas. The better structural designs of buildings, information technology, rescue operations, community awareness and disaster preparedness can prove helpful in mitigating this disaster.

• **LANDSLIDES** : Landslide is the sudden sliding of mass of rocks or earth down a mountain slope under action of gravity (Fig. 10.2). These are caused by heavy rains or melting of snow. The running water softens the upper soil and triggers sliding of rocks. Blasting and cutting of rocks for construction or widening of roads and deforestation also adds to this problem. Sometimes, the tremors of an earthquake are strong enough to cause landslides.



Fig. 10.2 Landslide

The massive landslides may destroy the human settlements along the mountain slopes. Buildings and plantations are buried under mud and debris. The roads are blocked and this disturbs the transport network. Pent up waters of a river or stream blocked due to landslides may result in flash floods. All this results in huge economic losses. In India, the landslides are very common in the



Fig. 10.3 Mountain ecosystem

north-east and north-west Himalayan regions.

The mountain ecosystem is very fragile (fig. 10.3). The frequency of landslides can be reduced by adopting proper protection measures. More and more trees should be planted in landslide prone areas. The roots of trees consolidate the surface soil of mountain slopes. The construction of wired stone blocks along roadside and near river bridges also provides support to the rocks and reduces sliding of slopes. Trained manpower should be employed and an appropriate quantity of explosive should be used to blast the rocks for road construction. Proper drainage of surface waters during rainy season can also minimize the magnitude of this problem.

MAN MADE DISASTERS

Man made disasters are associated with human activities. These include nuclear accidents, leakage of toxic chemicals, out breaking of fire, air crashes, accidents, collapsing of bridges and tunnels etc. Most of man made disasters are attributed to human errors and are generally unpredictable.

TECHNOLOGICAL AND INDUSTRIAL DISASTERS : Technological and industrial disasters are the most important man made disasters. These are caused due to lack of proper installations, flawed structural designs and improper handling of hazardous wastes and substances. Many-a-times, technical errors resulting from lack of adequate technical training also lead to technological disasters. The effects of these disasters become more pronounced when the operators lack awareness and are not well equipped with appropriate safety measures.

Several such disasters have been witnessed in the modern times. The Chernobyl nuclear disaster is the worst accident ever to occur at a nuclear power plant. It took place at the Chernobyl Nuclear Plant in the former Soviet Union on April 26, 1986. A nuclear reactor exploded and expelled about 50 tonnes of radioactive substances in the atmosphere. The effects of the accident were not restricted to the local area, but the radiation quickly spread across a large area of northern hemisphere. A number of fire workers died from exposure to high levels of dangerous radiation. More than 116000 people living within a 30 km radius around the nuclear plant were evacuated to safer areas. The accident caused death of 31 persons on the spot. As many as 24000 persons received an excessive dose of radiation. When the clean up operations were over, the damaged building of the reactor was covered under 300000 tonnes of concrete. Later on, the investigations made to identify the causes of this accident, revealed that the reactor was not housed in a containment building and was unstable at low temperature. Many of the plant operators lacked the full technical know-how.

On 3rd December 1984, the world's worst industrial disaster took place at the Union Carbide pesticide plant located in Bhopal, India. The highly toxic methyl isocyanate gas (used in manufacture of pesticides) leaked from the storage tank. It caused death more than 2300 people. About 14000 persons suffered serious injuries and health disorders.

These typical examples highlight the magnitude of huge damage which can be caused by technological and industrial disasters. The exposure to radiation can cause skin burns, cataract, sterility

and cancer of different body tissues. It can induce harmful changes in the genetic material. These changes may get inherited to future generations. Similarly, exposure to harmful chemicals may causes blindness, deafness, nervous disorders, sterility, kidney and liver dysfunctions. The governments of different nations, the scientists, the rescue workers, the engineers and the doctors have learnt a lot from these disasters. The aspect of nuclear power is being taken more seriously by different countries now. Proper safety measures are being developed and incorporated in the newly constructed nuclear power plants and other industries. The better safety measures, adequate technical training, structural stability and proper designing can minimize the technical and industrial disasters.

EXERCISE

(A) Very short answer type questions (1 mark each) :

1. What is a disaster ?
2. How many types of disasters are there ?
3. What is seismic focus ?
4. What is epicentre ?
5. Name the instrument used for measuring strength of an earthquake.
6. Write about the major cause of floods.
7. In which season of the year the floods occur more frequently ?
8. What is the speed of wind in a cyclone ?
9. What is a landslide ?
10. When did the Chernobyl nuclear disaster happen ?

(B) Short answer type questions (2 marks each) :

1. Differentiate between the natural and man-made disasters.
2. What is a cyclone ?
3. How can cyclone be predicated ?
4. What is desertification of land ?
5. Give two preventive measures for control of landslides.
6. Name two important man-made disasters.
7. What were the important causes of Chernobyl nuclear disaster ?
8. Write about the harmful effects of radiation exposure.
9. What is drought ?

(C) Short answer type questions (4 marks each):

1. How does an earthquake originate ?
2. What is the impact of drought ?
3. What should be done to prevent an control drought ?
4. How do the floods affect animal life ?
5. How does a cyclone cause devastation of human life ?
6. What are different causes of landslides ?

(D) Long answer type questions: (5 marks each):

1. Write about causes, impact and mitigation of earthquakes.
2. Discuss floods as a natural disaster.
3. Describe important types of man-made disasters.
4. How can different natural disasters be mitigated ?



CHAPTER-11

ENERGY CONSUMPTION

Energy is the capacity to do work. It is the basis of human life. No activity in this universe is possible without the use or transformation of energy. Human society depends on energy for its varied activities. Also, the energy requirements of the society have been changing fast with passage of time. Sources of energy and modes of its production have also been changing since the early man. As the civilization grew, energy became associated with quality of life and economic development.

CHANGING GLOBAL PATTERNS OF ENERGY CONSUMPTION

The early man was a hunter, a gatherer. His activities included food gathering, chasing and killing wild animals. The energy from food gave him the much needed physical or muscular strength for these activities. In other words, we can say that he obtained his entire energy directly from the food-chains. He was not aware of any other forms of energy and his demand of energy was very low. The photosynthetic activity of the green plants has been the primary source of energy for all types of food chains, since the origin of early life forms. With the discovery of fire, the early human beings made use of wood as a source of energy. They used fire for cooking meat, protection against wild animals and keeping themselves warm. As they learnt about the use of tools, they started practicing agriculture along the river banks. The domestication of animals helped in harnessing their muscular energy for agricultural tasks. As the civilization progressed further, the metal tools, besides discovery of wheel enhanced the working efficiency of human beings. The wheel and use of animals led to development of the cart. This facilitated transportation of things from one place to other. The animals such as ox, horse, donkey, bull etc. were used for carrying heavy loads, to do agricultural work and as means of transportation. Till 17th century, man used muscular, animal, wood, wind and water energy for carrying out different activities. The firewood obtained from forests was the major source of energy until the middle of nineteenth century. It alone accounted for about 50 percent of the world's total energy consumption around 1850. In rural India, firewood and agricultural waste are still used as an important source of energy. With further growth of civilization, the human activities became more diversified. The invention of steam engine played a key role in industrial revolution around the middle of nineteenth century. This resulted in setting up of large number of industries in Europe and America. In order to fulfill increasing energy demands, the use of firewood was replaced by discovery of coal, oil and natural gas. During the first decade of 20th century, coal accounted for 75 percent of the total energy consumption in houses, industries and transportation. The 20th century witnessed a great increase in the use of petroleum fuels like oil and natural gas. These petroleum products provided about 82 percent of the total global commercial energy consumption by 1984. The excessive use of these fossil fuels (coal, oil, natural gas) led to contamination of the environment. It was also realized that the fossil fuels are exhaustible resources and are not unlimited in nature. Their supply may come

to an end in the near future. In fact, it took millions of years in nature for formation of these fossil fuels by slow decomposition of tree, algae and small marine organisms.

In modern society, the consumption of energy is increasing very rapidly with the growing population. A major part of energy being consumed is used by industries associated with production of chemicals, minerals, food and other products. The transportation by automobiles and extensive agriculture involving heavy machinery also consume a great amount of energy. For domestic purposes, energy is used for cooking food, lighting, warming or cooling houses and running several home appliances. In view of exhaustible nature of fossil fuels, the renewable sources of energy such as hydropower or hydel energy, wind energy, solar energy, geothermal energy and biomass energy are also being exploited. Attempts are being made to develop more efficient technology for harnessing energy from these renewable sources.

The consumption of energy is not uniform in different parts of the world. Energy consumption rate is very high in developed countries like the United States of America (USA), Canada, Switzerland, Norway etc. According to an estimate, 22.60 percent of the global population that lives in developed countries accounts for 74 percent of the total energy consumption world over. The non-renewable sources (coal, oil, natural gas, nuclear energy) provide 90 percent of the total energy consumed in developed countries. Renewable sources such as hydropower, geothermal, biomass and solar energy account for the remaining 10 percent energy. On the other hand, in the developing countries like India and China, renewable and non-renewable sources provide 41 percent and 59 percent of the total energy consumption respectively. It indicates that less developed countries are obtaining a substantial amount of energy from their renewable sources, especially the biomass. In view of exhaustible nature of fossil fuels and the resulting environmental concerns, efforts are also being made to produce cost-effective alternative fuels such as methanol, ethanol, fuel cells etc. These sources relatively cause less pollution of the environment.

ENERGY CONSUMPTION AS A MEASURE OF QUALITY OF LIFE

The input in terms of energy consumption is directly linked with economic growth of a country in different sectors. It is a measure of richness or quality of life of the people of a nation or society. There exists a direct correlation between per capita income and per capita energy consumption. The higher consumption of energy indicates higher quality of life. The rich may afford to buy a car and make use of the fuel but the poor may not be able to buy a bicycle. There is great difference in per capita energy consumption between developed countries and developing countries. In developed countries, each person consumes nine times more energy than used by an average person in developing countries.

Owing to higher per capita energy consumption, 22.6 percent of the total global population living in developed countries consumes 74 percent of the total energy consumed world over. The per capita energy consumption in India is much lower than developed countries like the USA and Japan. The average daily use of energy by an American is 25 times more than used by an Indian. In 1984, the United States of America with about 5 percent of the global population accounted for 25 percent

of the world's total commercial energy consumption. On the other hand, India with 15 percent of the world's population used only 1.5 percent of the world's commercial energy. Higher energy consumption rate of developed countries indicates higher quality of life of people.

Country	Per Capita Income (in U.S. dollars)	Per Capita Energy Consumption (in Kg of oil)
USA	30600	8076
Japan	24041	4084
U.K.	20883	3863
Egypt	3303	656
Indonesia	2439	693
India	2149	479

(Per capita income and per capita energy consumption of selected countries in 1997)

(Source : The world development report 2000-2001)

The consumption of energy by a country depends upon many factors. These include the type of economy, climatic conditions, cost factor and availability of energy, state of economic development etc. The countries with industrial economy consume more energy than countries with agricultural economy. In countries with cold climatic conditions, a large amount of energy is used in heating buildings. The lower prices and easy availability of energy sources also result in higher consumption rate. Energy consumption in rural societies is lower in comparison with the urban societies. This difference is also reflected in standard of living. In India, 70 percent of population lives in villages and use about 40 percent of the total energy. More than 40 percent of the Indian population depend upon non-commercial sources of energy (fire wood, crop residues, animal waste etc.) and do not have the capacity to buy commercial sources of energy (oil, coal, natural gas, hydro-electricity etc.)

RISING DEMAND FOR ENERGY

The global demand of energy has been increasing every day since the dawn of industrial revolution. Most of this increase has taken place in today's more developed countries. The per capita energy consumption in these countries may have reached at or near saturation now. The population of these countries has become more stable. They need a greater amount of energy to maintain their current state of economic growth and standard of living. But in contrast to developed countries, the population in the developing countries is increasing at a high rate and most of the current increase in global energy consumption is occurring in these countries. One of the major goals of the developing countries is to improve the quality of life of their citizens. This objective is associated with rapid economic development in different sectors that require heavy inputs in terms of energy. This has led to an enormous demand of energy for different types of industry (metal, chemical, glass, paper, cement, fertilizer, food etc.), transportation means (highway vehicles, rail engines, ships, aeroplanes etc.), agricultural machinery and domestic services.

Most of the energy required for these activities is being harnessed from the fossil fuels including coal, oil and natural gas. About 82 percent of the world's commercial energy is being supplied by these non-renewable energy sources. In the developed countries, these fossil fuels account for about 85 percent of the total energy consumption. In this concern, the developing countries make a substantial use of their non-commercial energy sources (fire wood, crop residues, animal waste etc.) and use fossil fuels for about 58 percent of their total energy consumption.

The fossil fuels are not unlimited and may vastly decrease in the near future. The excessive use of these substances has also resulted in large scale pollution of the environment. Half of the world population uses firewood as a major source of energy. But the rapid deforestation is leading to shortage of firewood supply. The rising demand of energy and need to reduce emission of pollutants, have necessitated exploration of some suitable alternative sources of energy. India is a developing country and its demand for energy is increasing rapidly due to industrialization, transportation, mechanization of agriculture, urbanization, domestic use and other developmental activities. Out of the total energy consumed in the country, 50 percent is utilized by industry, 22 percent for transportation, 12 percent for domestic use and 8 percent for agriculture. The rural people use about 40 percent of the total energy of the country. Non-commercial sources such as fire wood, animal waste and crop residues account for about 80 percent of their energy demand.

Although, the per capita energy consumption in India is quite low but still there exists a shortage of energy supply. The gap between demand and supply is widening day by day. People have to encounter shortage of petrol, kerosene, diesel, cooking gas, electricity and firewood.

Country	Percentage of Global Population	Percentage of Energy Consumption
United States	4.6	2.5
China	21.2	9.9
Japan	2.1	5.8
India	16.6	3.1
Germany	1.3	3.9
France	0.9	2.9
Canada	1.0	2.5

(Energy consumption in some selected countries)

Our forests are not sufficient enough to provide required amount of firewood on sustainable basis. The consumption of different petroleum products in industry and transportation is increasing at a high rate. The crude oil production in the country falls short of its rising demand. More than half of the total requirement of petroleum products (petrol, diesel, kerosene etc.) is imported from other

countries. In view of present requirement and future demand, the natural gas reserves are also very limited in quantity. Efforts are being made to locate more gas reserves. In spite of an increase in the installed capacity of electricity generation every year, the electricity demand is much higher than this installed capacity. The demand of energy in different sectors is increasing each day but the energy sources of the country are insufficient to meet this demand generated by rapid growth of population and economic development.

EXERCISE

(A) Very short answer type questions (1 mark each) :

1. What is energy?
2. What were the activities of early man ?
3. What is the primary source of energy ?
4. When did early man start the use of wood as a source of energy ?
5. Name two important sources of energy in rural India ?
6. How were the fossil fuels formed in nature ?
7. Give two non-conventional sources of energy.
8. What is the major source of energy for different sectors ?
9. Which factor is responsible for shortage of firewood ?

(B) Short answer type questions (2 marks each) :

1. How did early man obtain energy ?
2. How did the discovery of wheel enhance the working efficiency of man ?
3. Why more emphasis is being given to exploit renewable sources of energy ?
4. Name two alternate fuels.
5. What is the reason for higher consumption of energy in developed countries ?
6. What are two limitations of fossil fuels as a source of energy ?

(C) Short answer type questions (4 marks each):

1. Write a short note on consumption of fossil fuels.
2. What are different energy consuming activities of the modern society ?
3. Explain different factors that determine energy consumption by a country.
4. Write about energy consumption by rural people in India.
5. Explain the demand and supply of petroleum products in India.

(D) Long answer type questions: (5 marks each):

1. Discuss the consumption of energy sources from ancient to modern times.
2. Write about consumption of energy in developed and developing countries.
3. Comment upon the statement “Energy consumption is a measure of quality of life.”
4. Discuss energy consumption pattern and problems in India.



CONVENTIONAL SOURCES OF ENERGY

Energy is harnessed from a variety of sources. The major conventional sources of energy include the fossil fuels and firewood. These sources account for most of the total energy consumption in the world. The fossil fuels (coal, oil, natural gas) are also known as non-renewable sources of energy because of their limited reserves in nature. It took millions of years in nature to form fossil fuels from the marine organism and green plants. The excessive use of these sources during the past century has resulted in widespread pollution of the environment.

COAL :

Coal is a solid formed from green plants trapped under sediments in millions of years. The varying degree of temperature and pressure during decomposition resulted in formation of different grades of coal. These grades differ in content of carbon, moisture and volatile compounds present in them. Lignite is a moist and soft grade of coal. It is brown or blackish brown in colour. It produces little heat than other grades of coal. The most common type of coal is bituminous coal. This brilliant black coloured grade is harder than lignite, contains sulphur and produces lot of heat on burning. The highest heat producing grade of coal is anthracite. It is hard, brilliant black and burns most cleanly causing relatively less pollution than other grades. All the three grades of coal present as underground deposits are removed through process of coal mining. Coal has proved as backbone of industrialization. It replaced the use of firewood. In addition to use as a major fuel in industry, coal is also used in preparation of coke, coal gas, synthetic petroleum and many organic compounds such as benzene, toluene, aniline, anthracene etc. Coal is the most abundant fossil fuel and its major deposits are in the United States of America, former Soviet Union and China. As per estimates made by Geological Survey of India (GSI) during January 2001, the proven coal reserves in India contain about 84.41 billion tonnes of coal. These reserves may last for about 200 years in future. Most of the coal reserves are located in Bihar, West Bengal, Andhra Pradesh, Madhya Pradesh and Maharashtra. In India, coal alone accounts for half of the total energy supply and about 60 percent of the coal is used for electricity generation. The demand is rising year after year.

The coal mining process and subsequent use of coal for different purposes cause substantial damage to the environment. During mining operations, vegetation and top soil are removed. This activity destroys natural habitats of wild animals. Burning of coal releases carbon dioxide, sulphur oxides and nitrogen oxides into the atmosphere. The long term emission of carbon dioxide since the industrial revolution, has initiated the problem of global warming. More amount of carbon dioxide per unit of heat is produced by burning of coal in comparison with other fossil fuels. The oxides of sulphur and nitrogen combine with water vapours present in the atmosphere and produce acid rain. Smoke generated due to coal burning contains solid particulate matter and results in pollution of the

air. The workers engaged in underground coal mining operations suffer from health injuries and respiratory disorders. The uninterrupted supply of coal to distantly located thermal power plants is not an easy task.

OIL :

Crude oil or petroleum is a dark oily liquid made up mostly of hydrocarbon compounds and small quantities of compounds containing sulphur, nitrogen and oxygen. The word petroleum is derived from the Greek words,

petra meaning rock and *oleum* meaning oil. It was formed in nature when large number of marine microscopic organisms died and got trapped under sediments.

Under the effect of heat and pressure these dead organisms got converted into crude oil over millions of years. The presence of a petroleum deposit is detected through exploration of impermeable rocks that form structural traps around it. The wells are drilled at promising sites and the petroleum is pumped out.

It is then separated into useful products such as gasoline (petrol), diesel, kerosene, naphtha, asphalt etc. This process of separating crude oil into different useful components is known as refining of petroleum (Fig. 12.1). For this purpose, petroleum is subjected to fractional distillation. This process involves heating of crude oil to evaporate different components at their specific boiling points. In the fractionating tower, these uprising vapours of different components condense at different levels and are subsequently collected.

Fractional distillation of crude oil provides us useful products and by products.

Crude oil is pumped into a fractionating tower where it is heated. The vapours rise and condense at different levels. The products are collected and used for various purposes. The diagram shows the following products and their carbon atom ranges:



Fig. 12.1. Refining of petroleum

Petroleum products such as diesel and gasoline are used in transport sector. The liquefied petroleum gas (LPG) collected during refining of petroleum is used as source of energy for cooking and heating. The petrochemicals obtained from crude oil are used in production of fertilizers, paints, plastics, pesticides, synthetic fibres and medicines.

Crude oil has emerged as a major source of energy since 1940s. It is easy to transport and burns more cleanly than coal. In India, about 40 percent of the petroleum products are used in transportation and the rest is used in industry and some other sectors. The domestic crude oil production of 33 million metric tones (2000-2001) is sufficient to meet about 35 percent of the annual demand. Contrary to this, the demand for petroleum products is rising very rapidly and our dependence on import is vastly increasing. The Indian crude oil deposits are 0.4 percent of the world's total proven reserves. These are mainly located in the states of Assam and Gujarat. The Organization of Petroleum Exporting Countries (OPEC) holds 77 percent of the world's total oil reserves.

As in case of coal, burning of oil also produces carbon dioxide and partly contributes to the problem of global warming. The nitrogen oxides released from burning of gasoline (petrol) in automobiles lead to acid precipitation in the atmosphere. The oil spills occurred during transportation of crude oil also result in severe damage to aquatic animals living in oceans. The out breaking of fire at oil refineries and oil deposits also causes air pollution.

NATURAL GAS :

It is a mixture of a few different hydrocarbons. These include especially the methane and smaller amounts of propane and butane. Natural gas was formed in nature in the same way as crude oil or petroleum, from marine microscopic animals trapped under the sediments over millions of years. Most of the natural gas lies above deposits of petroleum. Sometimes, it also occurs without petroleum. Butane and propane are removed from the natural gas. These are then stored in pressurized tanks or cylinders in the form of liquefied petroleum gas (LPG) that is used for cooking and heating. The remaining gas (methane) is then cleaned of impurities and pumped into pipelines for further distribution. It can be converted into liquefied natural gas (LNG) at very low temperature. Specially designed refrigerated tanker ships are used for transportation of liquefied petroleum gas.

Natural gas is used to generate electricity in power plants. It is used as a fuel in industries associated with manufacture of cement, ceramics, glass, bricks and food processing. Petrochemicals are also obtained from natural gas. These are used in production of plastics, medicines, detergents, fertilizers etc. The compressed natural gas (CNG) is used as a fuel in automobiles. In developed countries, it is also used to heat residential and commercial buildings. In India, the proven reserves of natural gas are about 749.65 billion cubic metre (BCM). The major reserves are in Assam, Gujarat and Bombay High. This energy source accounts for about 10 percent of the power generation. Efforts are being made to explore more gas reserves and setting up of supply pipelines.

Natural gas is the cleanest and hottest fossil fuel. It can be easily transported by pipelines. Liquefied natural gas (LNG) is highly volatile and inflammable. Accidents, when occur during transportation of natural gas over long distances by pipelines or specially designed tanker ships cause damage both to human life and environment.

• FIREWORD:

The fuelwood or firewood has been a major source of energy since early civilization. Till the middle of nineteenth century, it remained the most important source of energy. About half of the world population still depends upon firewood as primary source of energy for cooking and heating. Firewood is obtained from forests and is considered as a non-commercial source of energy. On burning, the chemical energy of wood trapped by photosynthesis is converted to heat energy. Firewood has several disadvantages. It contains a lower energy content and high moisture content per unit of weight. When burnt, it releases large amount of smoke and leads to indoor and outdoor air pollution. Oxides of sulphur and nitrogen also get added into the atmosphere. In India, the people living in rural areas obtain 80 percent of their total energy from firewood, animal waste and crop residues.

On a sustainable basis, our forests can provide only 28 million tones of firewood every year. But the demand of firewood is much higher than this available quantity. This demand is further increasing due to rising population. As a result, there is a pressure on our forests. Fire-wood is a renewable source only if the forests are not harvested faster than they grow back.

EXERCISE

(A) Very short answer type questions (1 mark each) :

1. Name major conventional sources of energy.
2. Which is the highest heat producing grade of coal?
3. Name the most abundant fossil fuel found in nature.
4. Where are the major coal reserves located in India?
5. What is the composition of petroleum?
6. What do you understand by refining of petroleum?
7. Name two important petroleum products which are used in transport sector.
8. Name the major hydrocarbon present in natural gas.
9. Which one is the cleanest and hottest fossil fuel?
10. What is the source of firewood?

(B) Short answer type questions (2 marks each) :

1. Why are the fossil fuels known as non-renewable sources of energy?
2. How was the coal formed in nature?
3. Write two important uses of coal.
4. How was the petroleum produced in nature?

5. What are the uses of LPG and petrochemicals?
6. How is LPG obtained from natural gas?
7. Differentiate between LNG and CNG.
8. What are the risks associated with use of natural gas?
9. Why is the demand of firewood increasing every year?

(C) Short answer type questions (4 marks each):

1. Write a short note on different grades of coal.
2. What are the adverse effects of coal mining?
3. How does coal burning affect the environment?
4. Explain the process of fractional distillation.
5. What are the consequence of petroleum use?
6. What are the important uses of natural gas?
7. Give some disadvantages of firewood.

(D) Long answer type questions: (5 marks each):

1. Write about formation, extraction, grades and uses of coal.
2. Discuss fromation, extraction, refining and uses of petroleum.
3. Describe the limitations and environmental consequences associated with fossil fuels.



NON-CONVENTIONAL SOURCES OF ENERGY

Non-conventional sources of energy include biomass, solar, wind, ocean, hydel, geothermal and nuclear energy. Most of these sources except for nuclear energy are inexhaustible and can be used indefinitely. These are renewed by nature and are also known as renewable energy sources. In comparison with fossil fuels, these sources cause less pollution of the environment. With rapidly expanding human population and ever increasing demand of energy, renewable sources are most promising alternative energy sources for long term use in future.

BIOMASS ENERGY

Biomass includes wood, fast growing plants, cattle dung and crop residues. It contains solar energy fixed in the form of chemical energy by green plants through process of photosynthesis. It is primarily used for cooking and heating. Biomass can be used in its solid form or it can be changed to liquid or gas fuels. Firewood can be changed into charcoal by partial burning. Cattle dung is used to make rounded dung cakes. It can also be used to produce biogas that is a mixture of gases especially methane (60-70 percent), carbon dioxide, hydrogen and hydrogen sulphide. Biogas is produced by action of micro-organisms in a biogas plant. For this purposes, cattle dung is mixed with water and put inside an airtight container called digester (fig. 13.1).

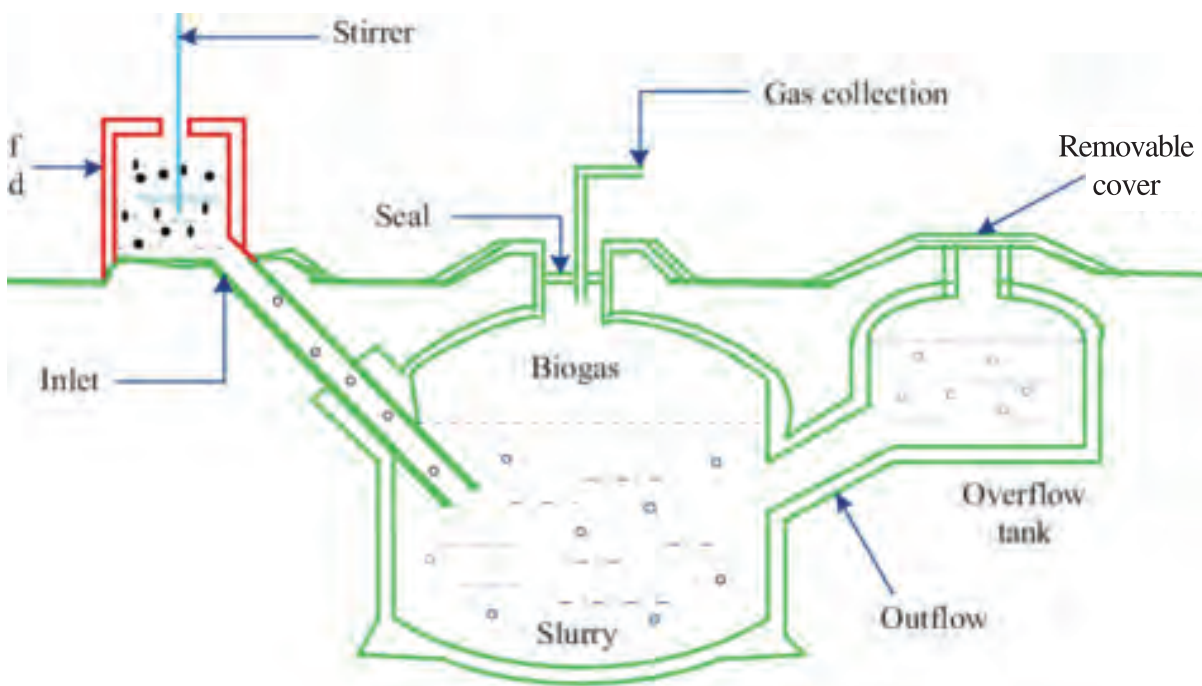

Fig 13.1 Biogas Plant

Under anaerobic conditions, the bacteria breakdown the undigested plant material of cattle dung into biogas. The remaining solid material is used as fertilizer for crops. Biogas can also be collected from household wastes and industrial wastes, dumped and buried in the landfills. Liquid fuels such as methanol and ethanol can be prepared from biomass and may be used in engines. Some plants like *Jatropha*, belonging to the family Euphorbiaceae yield useful oil which can be used as fuel in diesel engines.

As mentioned in the previous chapter, about half of the world population depends upon biomass as a primary source of energy. It acts as an inexhaustible energy source if managed in a sustainable manner. In rural India, biomass is the most important source of energy. There are more than 1.852 million biogas plants in India and potential exists for millions more. Cultivation of oil yielding plants is also gaining a momentum. There is a pressure on forest sources due to increased demand of firewood, Undoubtedly, the use of biomass decreases our dependence on fossil fuels, but it also contributes to the problem of global warming by increasing the level of carbon dioxide in the atmosphere. This problem can be minimized if biomass used is replaced by biomass regenerated. As in case of wood, other forms of biomass like animal waste and crop residues also release oxides of sulphur and nitrogen into the atmosphere. On burning biomass, a lot of suspended particulate matter is produced. Cutting of trees for firewood also leads to soil erosion and desertification. When biomass is burnt in traditional 'chullahs' or open fires, a large amount (80-90 percent) of energy is dissipated into the environment.

SOLAR ENERGY

Solar radiation falling on the earth's surface is most important renewable source of energy. Every year, the earth receives solar radiation equivalent to 1500 times the commercial energy consumption of the world. But the problem is that unlike fossil fuels and nuclear energy, solar energy is not concentrated in localized areas. It is dispersed over the vast surface of the earth. In order to harness this energy, the solar radiation is concentrated or trapped in a small area. This can be achieved through passive solar heating or active solar heating. Passive solar heating is used to warm buildings. It makes the use of green house effect and is the simplest, cheapest, pollution and maintenance free method for harnessing solar energy. Some radiation trapping structural features are incorporated in design of the buildings. These include large sun facing glass windows for receiving more solar radiation, a few or no north facing windows, walls and floors of concrete or stone and insulated curtains to reduce loss of heat during night. Passive solar heating can also be done by adding a small green house to the building. Similarly, in a solar cooker, the trapped heat energy is used for cooking food. The glass top and reflector of the solar cooker concentrate solar radiation inside the box. In order to absorb more energy, the inside of cooker is blackened and the cooking vessel is placed on a metal sheet.

Active solar heating is used to heat water. It involves the use of specially designed collection devices to concentrate solar energy (fig. 13.2). A typical collection device consists of a coil of cop-

per pipe fixed to a blackened metal base in an insulated box. This box is covered with glass. The absorbed heat is transferred to the liquid (water or antifreeze solution) or air inside the copper pipe. This hot substance is then pumped to an insulated water storage tank. This system is installed on the roof of building. It is more expensive than passive solar heating system. Both these types of solar heating systems supply free energy for warming buildings or heating water on sunny days. However, at night or on cloudy days, this supply of energy is not available.

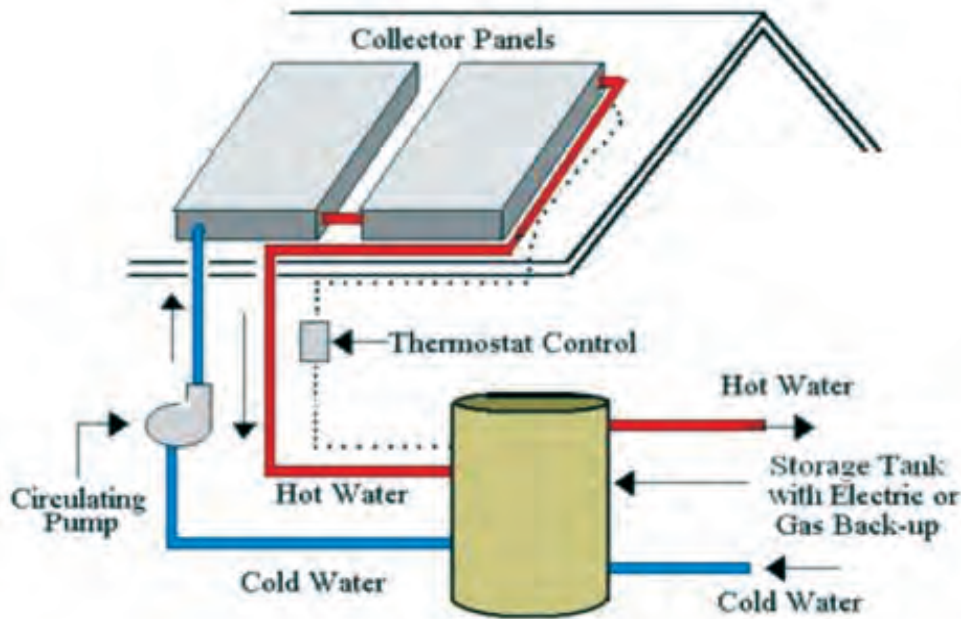

Fig. 13.2. Active Solar hot water heating system

Solar energy is used to produce electricity by solar thermal electricity generation. This process involves use of computer-guided mirrors that follow the sun for its optimum radiation. Trough-shaped mirrors are used to concentrate solar radiation on oil filled pipes. The oil is heated to 390°C and then pumped through a water storage system. The heat released from the oil changes the water into steam that turns a turbine to produce electricity. In another type of arrangement, the solar radiation concentrated by a large array of mirrors is focused on a boiler mounted at the top of a tower. The steam generated in this boiler is used to turn a turbine for producing electricity. Electricity can be directly produced from solar radiation by using photovoltaic cells. These cells are made up of purified silicon and small amount of other chemicals such as gallium arsenide or cadmium sulphide. When sunlight falls on a photovoltaic cell, it emits electrons and produces a small amount of electric current. In order to increase the amount of electricity, a large number of photovoltaic cells are coupled together to form a solar panel. Similarly, several solar panels can be wired together to further enhance the generating capacity (Fig 13.3). These panels can be mounted on the rooftops. The electric current produced by a photovoltaic cell is direct current (DC) and can be converted into alternating current (AC) by using an electronic converter. Solar cell technology has been used in satellites, electronic

watches, calculators, solar lanterns, street lights and water pumps. It is quite promising for smaller requirements.



Fig. 13.3. Solar panels

All these different types of methods for harnessing solar energy are being used in different countries. Efforts are being made to develop more efficient and less expensive technology. India is the third largest producer of solar cells and modules. More than 80 different industrial companies are engaged in marketing and manufacture of these items, The arid land in the deserts of Rajasthan offers a great scope for harnessing solar energy. A 30 MW Research and Developments cum demonstration project at Jodhpur in Rajasthan has already been sanctioned by the Government of India. Two 100KW partial grid interactive solar photovoltaic power projects have been commissioned in Uttar Pradesh. The Government is also providing partial financial assistance for installation of solar power operated irrigation pumps in different states. Solar energy has many advantages. It is renewable and abundantly available in nature. Use of solar energy causes no pollution of the environment. The only problem with this form of energy is that it is not available at night and during cloudy days. It needs a power backup system. The amount of solar radiation received by an area also depends upon season and geographical location.

WIND ENERGY

Warming of the atmosphere by solar radiation causes movement of air. Energy obtained from this moving air is known as wind energy. People have been using wind energy since 16th century. It is harnessed by wind mills. A windmill consists of movable blades mounted on a pole or a tower. Wind rotates the blades of a windmill. The mechanical energy produced due to rotation of blades is used to pump water and grind grains. The improved designs of windmills are also used to produce electricity. For this purpose, a small generator is attached with a windmill (fig. 13.4). Rotation of the

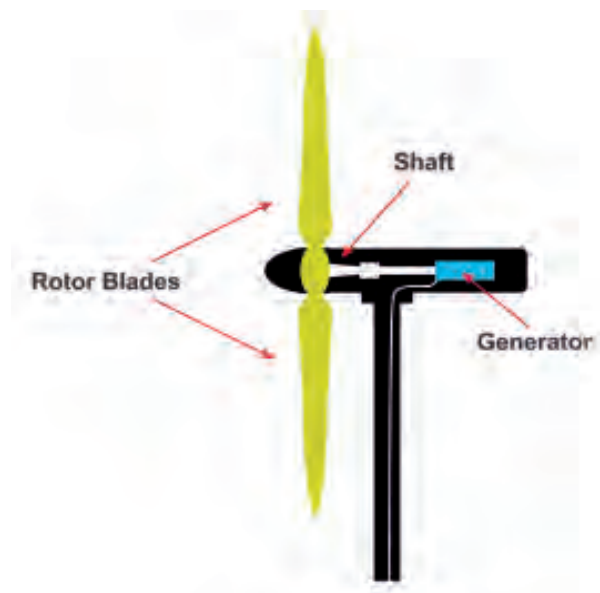

Fig 13.4. Wind turbine

blades drives the coil of the generator to produce electricity. The electricity producing wind machines are known as wind turbines. A single wind turbine produces a small amount of electricity. In order to increase electricity generation capacity, a number of wind turbines are installed in a large area and are wired together. This sort of arrangement is known as a wind farm. An ideal wind speed of 8.23 m per second is sufficient to run a wind turbine. Wind farms can be erected in areas having such favourable wind conditions. Under optimum wind conditions, an efficiency of 45 percent can be achieved. In India, Gujarat and Tamilnadu are leading states in production of wind energy due to availability of favourable wind conditions. A large wind farm capable of producing about 38 MW of electricity has been installed at Kaniyakumari. The wind power potential of India is estimated to be around 20000 MW.

Wind energy has certain important merits. It is a renewable source of energy and does not cause any environmental pollution. Wind turbines can be installed in remote areas where other sources of energy are not available. At the same time, the area occupied by a wind farm can also be used for other purposes. The major limitation of wind energy is that wind machines can only be operated in areas having a suitable wind speed. When the wind dies down, the wind turbines stop working. It has been recorded that even at the best sites, the wind turbines work only for about 60 percent of a calendar year. The moving blades of wind machines make noise and may kill the flying birds.

OCEAN ENERGY

Ocean water is a potential source of energy. Ocean thermal energy and tidal energy are two important forms of ocean energy that can be exploited for generation of electricity.

- (i) **Ocean Thermal Energy** : The ocean water receives enormous amount of solar radiation. The absorbed heat raises the temperature of surface waters. Contrary to this, the bottom

waters are quite cool. There may be a temperature difference of about 24°C between the surface water and deep bottom waters. This temperature difference can be exploited for harnessing the thermal energy trapped in the ocean water.

In an Ocean Thermal Energy Conversion (OTEC) plant, thermal energy of the ocean water is used to produce electricity. The hot surface water is pumped into heat exchangers of the OTEC plant to boil and pressurize liquid ammonia. The ammonia steam is then used to drive turbines for producing electricity. The bottom water from a depth of about 900m is pumped to surface for cooling ammonia back into liquid state. This liquefied ammonia is pumped back to heat exchangers to repeat the process again. The generation of electricity from temperature difference between surface and bottom waters of ocean is known as ocean thermal energy conversion (OTEC). A part of electricity generated by OTEC plant is used in the plant itself for pumping cool bottom waters to surface.

The world's first mini OTEC plant was designed and operated near Hawaii in 1979. On basis of successful experiments, large floating OTEC plants are technologically possible. A number of suitable locations for OTEC plants are available in different ocean areas. It is estimated that the ocean thermal energy potential of the world is around 1000000 MW and that of India is around 20000 MW. A proposal for installation of 100 MW OTEC plant costing rupees 750 crores in Tamilnadu is under consideration. Ocean thermal energy is a renewable and pollution free source of energy. It requires no land area for installation of OTEC plants. But the construction, operation and maintenance costs of OTEC plants could be too high. The sea water is highly corrosive and can damage the metallic parts of a plant. Large scale encroachment of sea water can also interfere and disturb the life of marine biota. Also, the efficiency of OTEC plant is supposed to be quite low and may require advanced technologies.

- (ii) **Tidal Energy :** The alternate rise and fall of ocean water due to gravitational pull of the moon and the sun is known as tide. It happens twice a day. As a result of tides, large volume of water flows in and out of inland bays, estuaries and other water bodies near the coastal area. The tidal energy associated with the rising and falling water can be used for generating electricity. It is possible by constructing a tidal dam across the narrow mouth of a bay. At high tide when the water level rises, the flood gates of the dam are opened and water flows into the bayside reservoir. Then the gates are closed. At low tide, the stored water is allowed to flow back out to ocean water. This out flowing water turns the turbines and generates electricity. The La Rance Power Station constructed across the Rance River in France is the world's largest tidal power plant. This dam receives water from tides upto 13.5m high. The experimental tidal power plant constructed at the Bay of Fundy in Canada has a water level difference of 16m between high and low tides. In India, the model tests to harness tidal energy are being tried. The Gulf of Kutch and the Gulf of Cambay in Gujarat and the Sunderbans in West Bengal have been identified as potential sites for harnessing tidal energy.

Although, tidal energy is a clean and renewable source of energy, yet it cannot become a significant source of energy on global basis. The reason is that the number of suitable sites for construction of tidal dams is very small. There are only about two dozen such sites worldwide. The construction cost of tidal dams is also very high. Moreover, building a dam in a coastal area may interfere with fishing operations and shipping industries of that area. Tidal dams would also hinder migration of several marine animals from sea to estuaries and back. The estuaries are favourable breeding grounds of these animals.

HYDEL ENERGY

The energy present in falling and flowing water is known as hydel energy or hydel power. In a hydroelectric power station, the energy of falling or flowing water is used to drive turbines for generating electricity. The large scale hydroelectric power stations make use of energy of the falling water. A high dam is constructed across a large river at a suitable site. The water of river is stored in the form of a large reservoir. Then this stored water is allowed to flow at a controlled rate to drive turbines installed at base of the dam. In a small scale hydroelectric power station, a low dam is built across a small river or stream and turbines are installed. The natural flow of the water source (stream or small river) is used to turn turbines for generating electricity.

The hydro electricity produced from hydel power stations accounts for about 25 percent of the total electricity production in the world. The mountain regions have great potential for generation of hydroelectricity. In countries like Norway, Congo, Brazil, Canada, Switzerland and Australia, most of the total electricity is produced from hydel energy. In India, hydroelectricity accounts for only 23 percent of the total electricity. The total hydroelectricity potential of India is estimated to be about 4×10^{11} KW. Out of this, only about 11 percent is being exploited presently. The major Indian hydroelectric power projects include Bhakhra-Nangal project, Tehri project, Damodar valley project, Hirakund project, Nagarjuna project and Naptha Jakhri project. There is a great scope of constructing small scale hydroelectric power stations in India. These small scale hydroelectric power stations can provide electricity in the remote areas where normal grid service is not available.

Hydroelectric power is an inexhaustible source of energy. Electricity generation by hydroelectric power plants does not release any pollutants in the environment. There is no need of a backup power supply system. Construction of dams also helps to control floods and provide water for irrigation, fisheries, drinking and recreational purposes. Although, the construction costs are high, yet the operation and maintenance costs are fairly low. Some drawbacks are also associated with hydel energy. When a large dam is constructed, a vast stretch of agricultural land is submerged under water reservoir. Thousands of people are displaced and natural habitats of a variety of wild animals and plants are destroyed. Natural flow of the river and migration of fish are disturbed. The nutrient rich soil accumulates in the water reservoir and fails to reach the agricultural land down stream. With passage of time, accumulated silt also reduces the water holding

capacity of the reservoir. Small scale hydroelectric plants cause little disturbances in their natural surroundings and are more environment friendly than the large scale hydroelectric power plants.

GEOTHERMAL ENERGY

The interior core of the earth is extremely hot. It contains molten rocks in the form of magma. At certain places, this magma comes to lie below the earth's upper crust and heats the subsurface rocks. The heat energy present in these rocks is known as geothermal energy. When the underground water comes in contact with these hot rocks, it starts boiling. Depending upon the temperature of rocks, underground water may get changed into dry steam, wet steam or hot water. The areas in which such reserves of geothermal energy exist are known geothermal regions. In some places, this hot water and steam gush out in the form of hot springs and geysers.

After locating a geothermal area, a bore is drilled to obtain underground deposit of steam or hot water. These sources of geothermal energy can be used for producing electricity. The deposits of dry steam are very rare. It contains no droplets of water and can be directly used to drive turbines for generating electricity (fig. 13.5). Wet steam is super heated water under high pressure. It is a mixture

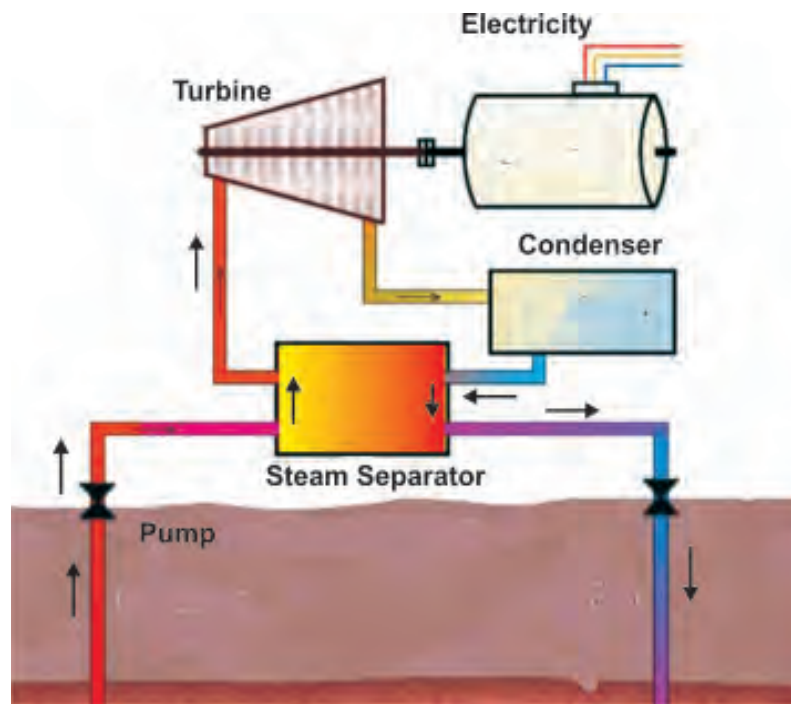

Fig. 13.5 Geothermal Power Plant

of steam and water droplets. In order to produce electricity from wet steam, it is first spun at high speed in a steam separator. The separated steam is then used to turn turbines. Deposits of hot water are more common than dry and wet steam deposits. Hot water is used to warm residential buildings, farm buildings and to dry crops. Electricity can also be generated from hot water. In a heat exchanger, the heat energy of hot water is used to evaporate and pressurize a hydrocarbon fluid. The

pressurized gaseous state of the fluid is then used to drive turbines for generating electricity. The scientific works in USA and UK have tested the technological possibility of harnessing geothermal energy from very deeply located hot dry rocks. They drilled test wells and pumped water into these wells. The heat of the rocks changed this water into steam that was collected back for driving turbines. Geothermal energy accounts for 1.6 percent of the total energy consumed in the world. Currently, about 22 countries are harnessing energy from their geothermal sources. More than 380 geothermal plants are being operated in these countries. In this concern, the leading countries are Italy, Iceland, Mexico, Japan, Indonesia, the Philippines and the United States of America. Though in India too, about 340 hot springs have been located, yet this energy could not be tapped on a large scale. A small project has been set up in Manikaran in Himachal Pradesh. Another 1 KW experimental generator is being operated on geothermal energy in the Puga valley in Ladakh region of Jammu and Kashmir. This valley is situated at an altitude of 4500m above sea level and the climate is very cold, especially during the winter season. The people use geothermal energy for space heating, poultry farming, mushroom cultivation and wool processing. The hot geysers in Madhya Pradesh are also being investigated for commercial harnessing of this energy. Geothermal energy does not depend upon weather conditions. Deposits of geothermal energy can supply energy to the adjoining areas on a moderate cost. It does not result in emission of carbon dioxide but it releases ammonia, hydrogen sulphide and radioactive elements as pollutants in air. The surrounding land may subside due to excessive removal of underground water. Geothermal energy is not available everywhere.

NUCLEAR ENERGY

The energy released during nuclear fission or fusion is known as nuclear energy. Nuclear fission involves splitting of a heavy atom (nucleus) into two smaller atoms (nuclei) with release of large amount of energy (Fig. 13.6). In this process, the large nuclei of a heavy element like Uranium- 235 or Plutonium - 239 are bombarded with neutrons.

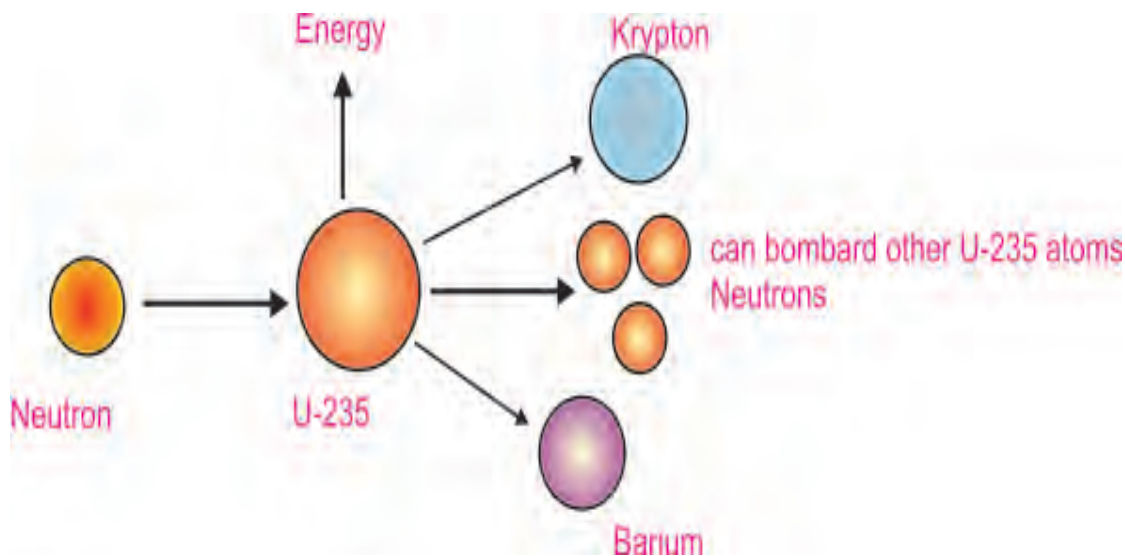

Fig 13.6 Nuclear Fission

Addition of a neutron into the nucleus of a heavy atom makes it quite unstable. This unstable atom (nucleus) immediately breaks into two smaller atoms (nuclei) and 2 or 3 neutrons are also ejected out. These neutrons then bombard the other atoms of the heavy element and trigger a chain reaction. A large amount of heat energy is generated at each step in this chain reaction. In nuclear fusion, two light-weight atomic nuclei join together to form a heavier atomic nucleus. For example, fusion of a deuterium atom (nucleus) with a tritium atom (nucleus) forms a helium atom (nucleus). This process is feasible at a very high temperature and produces tremendous amount of heat. On the basis of technological feasibility, nuclear fission reactors are used for harnessing nuclear energy. In this reactor, chain reaction is performed under controlled conditions. A typical nuclear reactor consists of four main parts namely, the reactor core, the steam generator, the turbine and the condenser (fig 13.7).

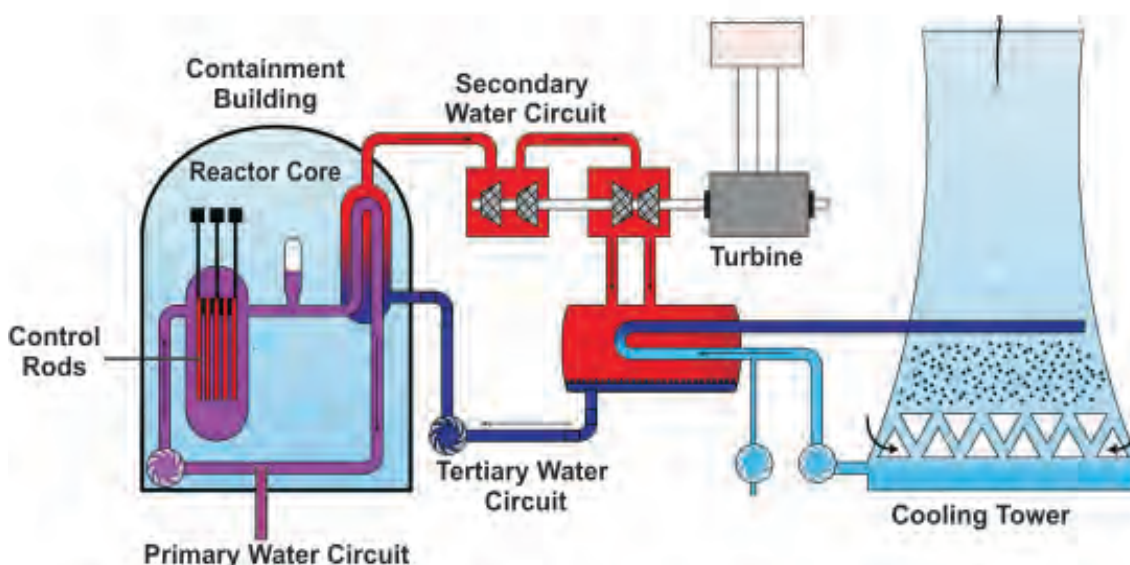

Fig. 13.7. Structure of a nuclear power plant

Fission of uranium fuel takes place inside the reactor core. The pellets of uranium dioxide are loaded in the fuel rods. The rate of chain reaction is controlled by using control rods made of special alloy. These can absorb the free neutrons produced during fission. The heat produced by fission is transferred to the steam generator by a primary water circuit. Water is heated in the reactor core to about 293°C. Under high pressure, it remains liquid and is circulated between reactor core and steam generator. The steam is produced from a secondary water circuit in the steam generator. It is then used to turn turbines for generating electricity. In the condenser, the waste steam is cooled back into liquid by a tertiary water circuit. The same process take place in the nuclear submarines and ships. The propelling force is obtained from the steam generated during nuclear fission taking place inside the nuclear reactors of these submarines and ships.

The first nuclear power plant was constructed in 1957 in the United Kingdom. By 1986, there were 374 commercial nuclear reactors in 26 countries, providing 15 percent of the world's electricity. The leading countries are the United States of America, Japan, France, United Kingdom, former

Soviet Union and West Germany. The Chernobyl nuclear disaster of 1986 raised several serious concerns over the safety of nuclear plants and disposal of the radioactive wastes. Since then, a number of countries have abandoned their plans to construct new nuclear power plants. In India, Tarapur Atomic Power plant in Maharashtra is the first nuclear power plant started in 1969. Three other atomic power plants include Rajasthan Atomic Power Plant, Narora Atomic Power Plant in Uttar Pradesh and Chennai Atomic Power Plant in Tamilnadu. The total power generation capacity of these atomic power plants is about 2005 MW. It accounts for only 3 percent of the total electricity produced in India. Uranium ores are found in Jharkhand, Andhra Pradesh, Rajasthan and the Himalayan region, These ores are processed into uranium fuel at Nuclear Fuel complex in Andhra Pradesh. The heavy water used as a coolant in nuclear reactors is produced in heavy water plants at Kota (Rajasthan), Baroda (Gujarat), Tuticorin (Kerala), Thal (Maharashtra) and Talcher (Orissa).

Unlike fossil fuels, nuclear reactors do not emit air pollutants such as carbon dioxide, oxides of sulphur, oxides of nitrogen and particulate matter. Nuclear energy is a highly concentrated source of energy. A small pellet of uranium dioxide contains energy equivalent of one ton of coal. Although, the chances of a nuclear accident are very low, but its consequences are very dangerous. The nuclear power plants produce radioactive waste that is extremely dangerous to human health and environment. It may cause inheritable genetic disorders. The appropriate methods for storage and safe disposal of this waste have not been fully developed so far. The total cost involved in construction, maintenance, operation, safety, measures, storage and disposal of radioactive waste and dismantling of an old reactor is considered to be very high.

NEED TO PROMOTE NON-CONVENTIONAL SOURCES OF ENERGY

Coal, oil, natural gas and firewood are our major conventional sources of energy. We have been exploiting these sources since long back. Firewood has been a major source of energy since early human settlements till the middle of nineteenth century. Then with the advent of rapid industrialization, coal became the major source of energy by end of nineteenth century. Oil and natural gas emerged as other major sources by 1930s. The long term use of these fossil fuels has resulted in serious environmental pollution. The quality of commons i.e., air, water and soil has deteriorated to a considerable extent. This has led to deleterious effects on human beings and other animals. Moreover, the reserves of these fossil fuels are not unlimited. These sources are non-renewable in nature. It has taken millions of years to form fossil fuels in nature. If the current rate of consumption of these fossil fuels continues, they may not last much longer in the future. In comparison with fossil fuels, the non-conventional sources of energy cause less pollution of the environment. Most of these sources such as solar energy, wind energy, ocean thermal energy, tidal energy, biomass energy and hydel energy are renewable in nature. These are used by man and replenished by nature. The nuclear energy has a great potential if all necessary safety measures are developed and incorporated in the future nuclear energy plans. The global demand of energy is increasing each passing day. In this concern, the non-conventional sources of energy are very promising alternative source of energy. Accordingly, there is an urgent need to promote non-conventional sources of energy.

EXERCISE

(A) Very short answer type questions (1 mark each) :

1. Name different non-conventional sources of energy.
2. Why are non-conventional sources also known as renewable sources?
3. How can firewood be changed into charcoal?
4. Name two liquid fuels that can be produced from biomass.
5. Give the composition of biogas.
6. Name an oil yielding plant.
7. Which one is the most important renewable source of energy?
8. What is a solar panel?
9. What is a wind turbine?
10. What is the ideal wind speed to run a wind turbine?
11. Define a tide?
12. Why are small scale hydroelectric plants considered more environment friendly?
13. Name any two localities where small projects for harnessing geothermal energy have been installed?

(B) Short answer type questions (2 marks each) :

1. What are the advantages of non-conventional energy sources over the conventional sources?
2. What is included in biomass energy?
3. How does a photovoltaic cell produce electricity?
4. What are advantages of solar energy?
5. What is the limitation of solar energy?
6. What is a wind farm?
7. Name four major hydroelectric power stations in India?
8. Write two drawbacks of hydel energy?
9. What is nuclear fusion?
10. Why should the non-conventional sources of energy be promoted?

(C) Short answer type questions (4 marks each):

1. How is biogas produced?
2. What are the disadvantages of biogas as a source of energy?
3. Write a short note on active solar water heating device.
4. Explain the structure and function of a wind mill.
5. Give a brief account of advantages and limitations of wind energy?
6. How does a hydroelectric power station work?
7. How are the different deposits of geothermal energy utilized?
8. Explain nuclear fission with an example.

(D) Long answer type questions: (5 marks each):

1. Describe different methods used for generating electricity from solar energy?
2. Discuss two important forms of ocean energy.
3. Give a detailed account of method of harnessing hydel energy. Also make a mention of its potential, advantages and drawbacks.
4. Elaborate the structure of a nuclear reactor. What are advantages and risks associated with nuclear energy?



CHAPTER-14

CONSERVATION OF ENERGY

The best approach to save energy for future needs is its conservation. It deals with the judicious use of different energy sources so that they do not deplete too fast. Energy can be conserved by eliminating or reducing unnecessary use of energy and by enhancing efficiency in its production, transportation and utilization. The unnecessary use or waste of energy can be easily eliminated or moderated by changing our energy wasting habits. One can contribute to save a significant amount of gasoline and diesel by walking or riding a bicycle for short (local) trips. In the heavy city traffic, cars and bicycles move almost at about same speed. The leg powered bicycles are very useful for short distances of 5-8km. For long trips, people should use public transport (bus or train) whenever possible. Energy and time can be saved by consolidating a trip to accomplish several tasks together. One should drive at an economy speed and should turn the scooter or car engine off while gossiping with a friend on road. The engines should not be warmed for more than a minute. Keeping the engines properly tuned also reduces fuel consumption. These fuel saving tips are also helpful in reducing pollution of the environment. In order to avoid unnecessary use of electricity, we should turn off the lights and other appliances when not in use. In winter season, the hot water should not be let running while bathing, washing clothes or dishes, brushing teeth and shaving. One should dress more warmly rather than using electric heaters to raise the room temperature. Such energy saving habits need to be encouraged.

CONSERVATION OF ENERGY SOURCES

The most important way for conserving energy is to increase efficiency in its production, transmission and utilization.

EFFICIENCY IN PRODUCTION

Efficiency in production refers to the amount of net useful energy produced in an energy producing industry. For example, in a coal based thermal power plant, coal is burnt to produce steam for generating electricity. A large amount of coal energy is lost during conversion of chemical energy into electrical energy. But if the coal is burnt more efficiently adopting advanced methods, the same amount of coal can be used to produce rather more electricity. The conversion efficiency of gas based thermal power plants is more than coal or oil based power plants. A considerable amount of coal is lost during mining and its subsequent handling. The use of improved techniques of mining and coal handling can prove helpful in saving a lot of precious coal which is otherwise lost. There is a need to increase energy production from renewable sources like water, wind, solar, biomass, geothermal and tidal energy. Currently, the renewable sources are contributing only about 17 percent of the total energy being consumed in the world. The remaining 83 percent of energy is provided by non-renew-

able fossil fuels. The renewable sources are quite promising alternatives to fossil fuels. An increase in energy production efficiency from these sources would definitely reduce the pressure on exhaustible fossil fuels. In the developing countries, the hydroelectric power potential has not been adequately tapped. It has been estimated that the hydroelectricity potential of India is about 4×10^{11} KW, but only 11 percent of this potential is being utilized. There are several untapped potential sites in the mountainous regions of the country. Most of these sites are suitable for construction of small scale hydroelectric power stations. Installation of more small scale power plants can increase electricity production.

Wind energy is a cheap and clean source of energy. The improvements in design of wind machines have resulted in an increase in their power production efficiency. The wind power experts are hopeful to achieve 35 percent efficiency with further development of this technology. The studies conducted by the United States Department of Energy and World Bank highlight that India has a great potential for wind power. It is estimated to be around 20000-25000 MW. At present, the installed capacity of wind energy is only 550MW. The development and use of wind energy need to be encouraged for conserving non-renewable energy sources. Similarly, in solar thermal power systems, about 22 percent of the energy that hits the heat collector is converted into electrical energy. Different countries are making efforts to develop more energy efficient and cost effective solar cells. In rural areas, firewood is a major source of energy. But it remains a renewable source as long as we use it in a sustainable manner. The ever increasing demand of firewood has resulted in a large scale deforestation, floods and soil erosion. In order to conserve this source, a massive afforestation drive is very essential. The pressure on forest sources can also be reduced if the use of biogas is promoted. In addition to production of gas, biogas plants also produce very useful manure. Liquid fuels such as ethanol and methanol prepared from biomass and oil produced by certain plants have been successfully tested as alternate fuel for internal combustion engines. The development of more energy efficient technology could play a key role in enhancing production efficiency of different renewable sources.

EFFICIENCY IN TRANSMISSION

Energy can be saved by installation of cogeneration units (Fig 14.1). Cogeneration involves using waste or left over steam. In a thermal power plant fossil fuel is burnt to produce steam from water. This steam turns the turbine for generating electricity. Then this steam is cooled and pumped back to the boiler. In a cogeneration unit this leftover steam is used to do some useful work before cooling. It can be used for cooking, space heating or for operating industrial machinery. The electricity generated from power plants is supplied to different areas by electric supply lines. For this purpose, step up and step down transformers are used for increasing or decreasing the voltage. During this transmission a fraction of the power may be lost due to technological factors. In developed countries, only about 7 percent of the electric power is lost during transmission. But in India, the transmission losses are exceedingly high. About 20-23 percent of power is lost during distribution. The transmission losses are largely due to theft of the power. It can be prevented by

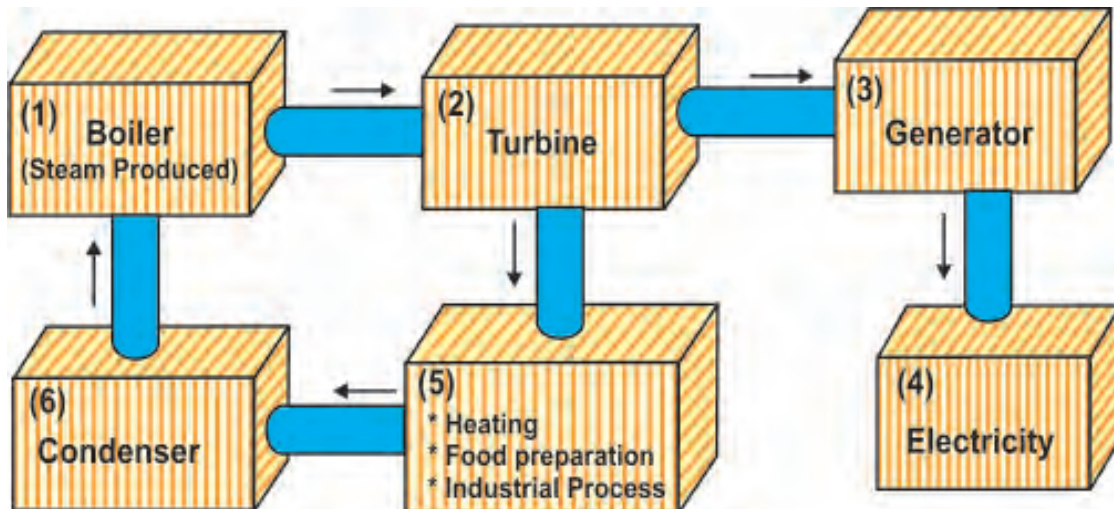

Fig 14.1 Cogeneration Unit

strict implementation of the rules, besides adopting ethical approach. The transmission losses resulting from technical factors can be minimized by using advanced type of energy- efficient transformers and high-tech-conductors. Recently the technology for transmission of power at high voltage in its DC (direct current) form has been developed. This has proven very helpful in minimizing the transmission losses. These innovative techniques can be incorporated in future plans.

EFFICIENCY IN UTILIZATION

Most of the energy harnessed from different renewable and non-renewable sources is utilized in industries, transport vehicles, domestic services and agriculture. An increase in energy utilization efficiency in these sectors could enable us to do more work with less amount of energy. In India, industry (paper, plastic, cement, textile, fertilizer, pharmaceutical, chemical, food processing and metal industries) alone consumes about 50 percent of the total energy. In industrial sector, lot of energy can be conserved by using energy efficient machinery and adopting energy saving processes. The timely maintenance of heavy industrial machinery results in its better energy utilization efficiency. Roughly about 66 percent of the total electricity consumed in the world is used for running electric industrial motors. The power saving improvements in the structural design of motors could minimize the total electricity consumption. Recycling of certain substances such as glass, plastics, paper, discarded aluminium cans etc. is also helpful in reducing the use of electricity. For example, a large amount of electricity is consumed for production of aluminium worldwide. If recycled aluminium is used, this electricity consumption can be reduced by 90 percent. Owing to advanced technology, Japan is making most efficient utilization of energy in industries. Countries like West Germany, Italy, Spain and France also have high efficiency in industrial utilization of energy.

Transport is the second largest energy consuming sector after industries. It accounts for about 22 percent of the total energy consumption in India. About 40 percent of petroleum products are utilized in transport sector. The number of automobiles is increasing day by day. The total number of

automobiles in the world was 520 million in 1999 and it is expected to increase one billion by 2018. The increasing number of vehicles has led to a rapid rise in demand of gasoline and diesel fuels. The energy utilization efficiency in automobiles has been significantly increased by improving aerodynamic designs and fuel efficiency of engines. Automobile companies like Honda, Mercedes, Tata, Ford, Toyota, Suzuki, Fiat etc. have developed several fuel efficient models of different automobiles. Durable and light weight material is used of fabrication. The engines that can run on natural gas and rechargeable batteries have been developed. Efforts are also being made to use hydrogen as a fuel for automobiles. Alcohol fuels like methanol and ethanol are much cleaner than gasoline. These can be prepared from biomass sources and are already in use. An efficient public transport system, using buses and trains can reduce use of private vehicles by people. In addition to saving of energy, this would reduce pollution too.

Energy can also be conserved at home and farm. The use of standard energy efficient appliances such as refrigerators, air conditioners, freezers, washing machines, cloth dryers, mixer-grinders, ovens, hot water geysers, water pumps, water coolers, electric generators, televisions etc. can save lot of energy. The energy efficient models of these appliances may cost slightly more but these products are more useful on a long term basis. Proper maintenance of agricultural machinery such as pump sets, electric motors, diesel engines, combines, tractors, automatic loaders, power operated sprayers etc. is very necessary to minimize waste of energy. Compact fluorescent light tubes consume only 25 percent of the electricity used by incandescent bulbs. Similarly, in the rural areas the use of improved *chullahs* is more beneficial than the traditional *chullahs*. In improved *chullahs*, firewood is burnt more efficiently and a chimney is used to eliminate smoke. The energy utilization efficiency of an improved *chullah* is 10-15 percent more than a traditional 'chullah'. In countries with cold climate, a large amount of energy is needed to heat residential and commercial buildings. A lot of energy can be saved if the necessary energy saving features are incorporated in the structural design of these buildings. Efforts are also being made to use nanotechnology for enhancing efficiency in utilization of energy. Nanotechnology deals with use and making of extremely small sized devices. The size ranges between 1 nanometer to 100 nanometer. One nanometer is equal to one billionth of a meter. Per capita utilization of an energy source depends upon its price also. Obviously, the low price results in high consumption rate. A large amount of energy can be saved from unnecessary use or waste by people if a rational pricing policy is adopted. There should be incentives for consumers who use the energy sources more efficiently. The people should be made aware about the judicious use of energy sources and protection of environment.

FUTURE SOURCES OF ENERGY

Petrol and diesel are two important petroleum products that are most widely used as fuel in automobiles. There has been a rapid rise in the demand of these non-renewable fuels due to ever increasing number of automobiles. The long term emission of pollutants released by automobiles has caused pollution of the environment. This has necessitated a search for alternative fuels for motor

vehicles. In this concern hydrogen, alcohol and fuel cells are being considered as promising alternative sources of energy in future.

HYDROGEN

It occurs in trace amounts in nature. But it can be produced by electrolytic, thermal or photolytic decomposition of water. In its gaseous state, hydrogen has a very low density. Hence, large sized containers are required for its storage. In order to overcome this difficulty. It is normally stored in liquid or solid form. Liquid hydrogen is called as cryogenic hydrogen. It is stored in specially designed storage tankers. Hydrogen can be used as a fuel in specially designed automobile engines and fuel cells. In its liquid form, it is used as a fuel in space ships. It can also be used to produce other fuels. For example, it reacts with carbon monoxide in the presence of a heated catalyst to form methanol. When burnt with pure oxygen, hydrogen yields only water vapours and no pollutants are emitted into the atmosphere. The calorific value (150 KJ per gram) of hydrogen is much higher than that of other fuels like petrol, diesel, ethanol etc.

The automobile companies are trying to develop cars in which liquid hydrogen produced by solar electricity could be used as fuel. The other serious problem is that hydrogen is a highly explosive gas. An explosion of a storage tanker or transport tanker may cause a serious loss of life and property. The technology to use hydrogen as a source of energy is in its developing phase. Hydrogen is being considered as an important fuel source for future use.

ALCOHOL

Ethanol and methanol are two important alcohols that can be used as liquid fuel substitutes for petrol (gasoline) and diesel. Both of these alcohols can be produced from biomass which is a renewable source of energy. Liquid ethanol (ethyl alcohol) is also called as grain alcohol. It is a clear, colourless liquid with a characteristic odour. It can be produced from a variety of sugar and grain crops by process of fermentation and distillation. These crops include sugarcane, sugar beets, potatoes, sorghum, corn etc. Fermentation refers to the production of ethyl alcohol and carbon dioxide from sugar present in different substances by an action of yeasts.

Methanol (methyl alcohol) is also known as wood alcohol. It can be produced from wood, agriculture wastes, garbage, sewage sludge, coal and natural gas. These alcohols can be burnt as fuels both in light and heavy automobiles. Use of pure ethanol or methanol as a fuel needs some modification in the conventional engines. However, gasohol (a mixture of gasoline and 10-23 percent ethanol) can be directly used as a fuel in conventional gasoline engines. Similarly, diesel can be mixed with 15-20 percent methanol to form Dieshol that can be used as a substitute for regular diesel fuel. Countries like Brazil and Zimbabwe have already started the use of gasohol as a liquid fuel for automobiles.

Ethanol and methanol burn more cleanly than gasoline and diesel. They release fewer air pollutants. But currently, these alcohols are more expensive than fossil fuels. Researches are trying to develop more efficient production techniques and special type of engines for these alcohols. Technological improvements could bring their costs down in future.

FUEL CELLS

A fuel cell is an electrochemical device that generates electricity directly from chemical energy. It consists of two electrodes which are separated by an electrolyte. Several types of fuel cells having different operating temperatures have been developed. A fuel cell looks like a battery but it does not store chemical energy. Hydrogen is fed into it as a fuel at anode (fig 14.2).

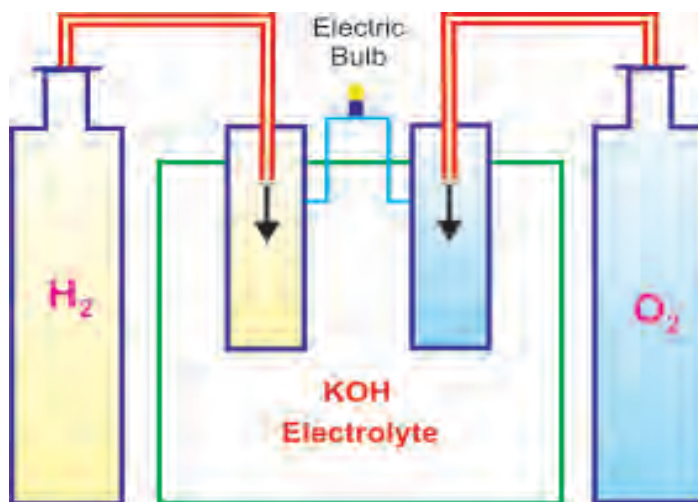

Fig. 14.2 Working of a Fuel cell

Oxygen is fed into it at cathode. In the fuel cell, these gases react to produce water and electricity. Fuel cells have very high energy efficiency because no combustion is involved and chemical energy is directly converted into electricity. Fuel cells can be used to run automobiles by replacing internal combustion engines with traction motors that can run on electricity produced by fuel cell. Electricity generated by fuel cells can also be used for several other purposes. They could prove very helpful in providing electricity to commercial buildings, hospitals, airports and military stations located in remote areas of a country. Fuel cells are modular structures and can be given different shapes as per need. They do not cause any serious pollution problem. The current costs of producing electricity by fuel cells are quite high. After further research and development, fuel cell technology could become available for widespread use in future.

EXERCISE

(A) Very short answer type questions (1 mark each) :

1. What do you mean by conservation of energy?
2. What is the impact of increasing demand of firewood?
3. Name two liquid fuels that can be prepared from biomass.
4. What is the significance of energy efficient appliances at home?
5. What is nanotechnology?

6. How many nanometers are there in a meter?
7. Give the reason for increase in demand in petrol and diesel.
8. What is cryogenic hydrogen?
9. Which chemical is known as grain alcohol?

(B) Short answer type questions (2 marks each) :

1. How can we avoid unnecessary use of electricity?
2. What is cogeneration?
3. How can India increase its hydroelectricity potential?
4. Suggest two ways for conserving firewood.
5. What are the reasons for excessive electricity transmission losses in India?
6. Name any four electric appliances used at home.
7. What is fermentation?
8. What is fuel cell?

(C) Short answer type questions (4 marks each):

1. Mention some fuel saving techniques.
2. What should be done to minimize the electricity losses during transmission?
3. How can energy be saved at home and farm?
4. Write a note on production and storage of hydrogen.
5. What are different limitations of hydrogen as a source of energy?
6. Differentiate between gasohol and dieshol.

(D) Long answer type questions (5 marks each):

1. Discuss the importance of efficiency in production for conservation of energy.
2. How can energy be conserved in industry and transport sectors?
3. Explain the structure and working of a fuel cell.
4. Write about production, potential and advantages of alcohols as future source of energy.



SAFE WORK ENVIRONMENT

Industralization has resulted in establishment of innumerable smaller and larger industrial units across the world. Millions of people work in these industries and handle varied jobs involving operation, production and maintenance activities. While discharging their duties, they encounter the possible danger of major and minor accidents. Generally, these accidents are the result of unsafe working environment, human carelessness, unsafe actions and different (physical, chemical, mechanical, electrical, biological, radiation and psychological) occupational hazards. Every year a large number of industrial workers suffer death or disability due to these accidents. Now-a-days serious attention is being paid to prevent industrial accidents and control different types of hazards at work place. Industrial safety has been recognized as an important aspect of industrial management. If an organization does not undertake appropriate safety measures, there are chances of industrial accidents. On the other hand, a safe work environment not only reduces casualties but it also proves as a great motivating factor for workers. It enhances the productivity of an industry. In this concern, adequate light, ventilation, cleanliness and good housekeeping should be regarded as important components of a safe work environment.

ADEQUATE LIGHT

As a form of energy, light stimulates sensory cells of our eyes and produces vision. While performing any activity an individual worker depends more on sight than on the other senses of the body. Inadequate light at work place makes a man partial blind and may result in casualties. Hence, in order to ensure a safe work environment, all walkways and work areas in an industrial plant should be properly illuminated. The effect of light depends both upon its intensity and quality. Intensity of light should be sufficient to enable the workers to operate machines, handle different tools and move freely without experiencing any eye strain. Human eye is unable to accommodate sudden changes in light intensity. It is desirable that the intensity of light should be somewhat uniform at different adjacent sites in an industrial plant. A contrasting difference of intensity at two neighbouring sites may interfere with normal vision and thus prove fatal. Natural light from the sun is preferred. Lights should be positioned at proper sites and light switches should be easily accessible. Misadjusted reflectors or other reflecting surfaces may produce glare that may lead to an accident. Unshaded light sources installed directly in line of vision also produce strong glare. Exposure of fluorescent lights should be avoided. These lights produce headache, eye strain, eye irritation, stress and fatigue. Exposure to very strong fluorescent lights may result in skin cancer and allergies. Similarly, flickering lights may cause hyperactivity and eye strain. A poor arrangement of lighting system can also cause electric shocks, burns, fires and slips from elevated surfaces. The defective lights, light fittings, and

cabling should be immediately repaired or replaced. An industrial unit may have to have a sudden power supply cut or failure of lights due to some technical faults. Under such conditions, provision of emergency lights can minimize the chances of industrial accidents.

VENTILATION

The major aim of ventilation is to keep the air inside an enclosed space or room fresh and pure. Different work areas inside an industrial plant or office should be well ventilated. Proper ventilation is very essential if the manufacturing process in an industry gives rise to smoke, dust, fumes etc. In lack of sufficient ventilation, the level of carbon dioxide inside an enclosed work place increases due to respiration or other processes. At the same time, the heat generated by machines is not dissipated and the temperature of the work place starts rising. Moisture, smoke, impurities, dust and poisonous fumes released during manufacturing processes also accumulate in the work area. All these factors make the work area uncomfortable and unsafe. This reduces the working efficiency of the employees and may also lead to serious health hazards. The employees may become victims of air borne disorders, particularly, those of the respiratory system. Proper ventilation reduces the fatigue of workers by creating a comfortable and safe work environment. It provides adequate supply of oxygen or air for respiration and also prevents accumulation of heat, fumes, dust, impurities, moisture etc. There are two main methods of ventilation i.e. natural and artificial. Natural ventilation is brought about by air entering through windows and other openings. If it does not serve the purpose, artificial or forced ventilation should be provided. The air inlets should be sited at suitable positions in such a manner that incoming air is free of impurities. In case of air conditioning system, the air should be filtered before recirculation and some fresh air may also be added it. In order to increase the efficiency of a ventilation system, it must be regularly cleaned and maintained. There should be no obstructions to air flow, near the ventilation system.

CLEANLINESS

General cleanliness helps in creating and maintaining a safe work environment. It increases concentration and efficiency of workers by providing them health friendly surroundings. Daily, weekly or monthly cleaning procedures should be adopted for work area, rest areas, furniture, machines and tools. Cleanliness should be considered as an integral part of the performance duties of the staff. Bathrooms, canteen counters, dishes, floors, work tables, small water containers, telephones, keyboards, display monitors, control panels of machines etc. should be cleaned on a daily basis. Paper, rubber pieces, cardboard, plastic pieces, discarded files, tissue papers etc. should not be thrown here and there. to litter the surroundings of a work place. There should be sufficient number of waste containers located at appropriate sites in canteens, staff lounges, rest rooms and other places. To avoid injuries due to falls and slips on wet floors, liquids spilled on the floors should be wiped up immediately. The staff members of an industry should not consume the eatables at their work places on dirty desks. Improper light conditions, scattered food items, dirty bathrooms, dishes and kitchen counters may result in rapid multiplication of disease causing micro-organisms. It ultimately leads to

absenteeism due to allergies and other forms of illness. Use of disinfectants such as phenols, acids, alkalis, hydrogen peroxide and formaldehyde can prevent the growth and multiplication of disease causing agents. Workplaces should be kept free from harmful insects and rodents to ensure a safe work environment. Cleanliness of tools, machines and other equipments reduces damage and helps in safe handling.

GOOD HOUSEKEEPING

Good housekeeping plays an important role in preventing injuries and accidents. It is not simple cleanliness, but rather, an orderly arrangement of things at their suitable places. Scattered papers, products, tools and other materials at work place create a frightening and purposeless work environment. Clutter at work places, rest areas, walk ways and storage sites results in improper use of space, whereas, good housekeeping provides more efficient use of space and time in an office or industry. Projecting nails, metal scraps, glass pieces, wires etc. may cause injuries to hands or other body parts. Poorly stacked materials may also fall off the shelves. Misplaced toxic, reactive or inflammable materials (LPG cylinders, diesel, kerosene, petrol etc.) may result in serious industrial disasters, leading to severe loss of life and property. A well planned good housekeeping coupled with general cleanliness provides a safe, comfortable and efficient work environment. It lowers the chances of exposure to different occupational hazards at work place.

SAFETY AWARENESS AND MANAGEMENT

The common work places include homes, laboratories, workshops and worksites. In view of rising trend of industrial accidents, safety awareness among workers, their family members, supervisors, contractors, industrial security persons and general public is a must for reducing casualties at these work places. In the same concern, the National Safety Council was established on March 04, 1966 at Mumbai with an objective to generate, develop and sustain a voluntary movement of health, safety and environment at the national level.

SAFETY PRECAUTIONS AT HOME :

If necessary safety precautions are not observed at home, certain common instruments and practices may become a cause of serious injuries. Falls from stairway and slips from wet floors may easily result in fractures of body parts, leading to death or disability. An injured person never returns to the earlier state of independence. Stairways should be free of scattered objects. Liquids spilled over the floor should be promptly wiped up. Necessary supervision and support must be provided to elders and youngsters, while they climb up or down the stairs. Gas stoves should be used with adequate caution. A regular inspection of gas supply line may prevent leakage and subsequent losses due to fire. To avoid pollution of the indoor environment caused by chemicals sprays, smoke, dust, etc, an efficient natural or artificial ventilation system must be introduced. If indoor pollution is not controlled properly, it may lead to certain allergies and other health problems. All these preventive measures make a home a safe place for working and living.

• **SAFETY PRECAUTIONS IN A LABORATORY :** Different types of laboratories in academic institutions, research centres, hospitals and industries are places of potential accidents or hazards. The student and employees handle different poisons, salts, explosives, electrical equipments, glass-ware, micro-organisms etc. at these work places. If suitable safety precautions are not adopted in a laboratory, fire accidents, toxicity, exposure to harmful chemicals and radiation may take place. One must wear suitable apron or mask, as a protective clothing to avoid injury arising out of radiation, acids, alkalis or heat exposure. Bottles containing different chemicals must be labelled and located at their appropriate places (Fig 15.1)



Fig. 15.1. Chemicals should be labelled properly

The inflammable substances must be stored in a separate cabinet. Fire fighting materials such as fire extinguishers or sand filled buckets must be kept at easily approachable points. For ensuring proper ventilation, exhaust fans should be installed. In a clinical diagnostic laboratory, samples of blood, sputum, urine, semen etc. must be handled with great caution. Use of gloves, masks and aprons is highly recommended in these laboratories, otherwise the investigators themselves may become victim of infectious diseases. Disinfection of work tables, floors and other places should be done to make them free of germs. The electrical instruments in a laboratory should be switched on only when required and should be switched off when not in use. All electrical connections must be properly insulated. There should be no obstructions in drainage system of a laboratory. Display charts conveying 'Dos & Dents' may also be hanged at different points in a laboratory. A first aid-box containing some much needed materials must be provided in laboratory.

SAFETY PRECUATIONS IN A WORKSHOP :

A workshop is a room or building where things are made or repaired using tools and machines. Human carelessness, unsafe activities, mechanical factors and unsafe environmental conditions are major factors responsible for accidents occurring in workshops. Safety precautions help in minimizing frequency and magnitude of these accidents. Periodic inspection of machines and tools is very

essential to reduce the losses due to mechanical factors. Similarly, proper conditions of light, ventilation, temperature, moisture and space play a key role in creating a safe work environment inside a workshop. In addition to these factors, certain safety precautions must be followed by the employees. They should wear mechanical safeguards such as safety clothing, shoes, goggles, helmet etc. for protection of different parts of body. Loose dresses should be avoided. While operating different machines, standard instructions should be followed and shortcuts should not be tried. Tools should be placed at their suitable places after use (Fig. 15.2). Misplaced hammers, screwdrivers, chisels, electric drill machines, spanners etc. may fall off and cause injuries.



Fig 15.2. Tools should be placed properly

Safety covers and wire meshes fitted over moving parts of a machine should not be removed. Electrical connections and insulation should be checked at regular intervals. It should be made sure that safety switches and limit switches of different machines are in working condition. Power supply should be switched off before repairing a machine. Workers in a state of intoxication, illness and extreme fatigue should not be allowed to work on machines. Attempts to do work at an exceedingly high speed may prove dangerous. In order to provide prompt treatment to a worker who suffers an injury, a first-aid-box must be made available in a workshop.

SAFETY PRECAUTIONS AT A WORKSITE :

Worksites are places where the construction of dams, buildings, bridges, roads etc. and activities like mining work are in progress. At these sites both skilled manpower and labourers work together. Poor quality of construction material (cement, ispat, bricks, wood etc) may result in collapsing of bridges and buildings, even before completion of construction work. In this regard, certain standards need to be followed. Before triggering a blast at a dam or road construction site, the passers-by and other people working nearby that area must be informed. If needed, labourers may be provided with body protection devices. Regular survey of construction site, machinery engaged and activities being carried out is very essential to identify the potential hazards. Crane elevator cables used for lifting

heavy loads should be regularly inspected and replaced when required. Installation of instruction boards such as 'Men at Work' or 'Work in Progress' at suitable points also helps in reducing accidents at worksites. Excessively long duration of work, excessive overtime and inadequate rest periods should be prevented. For avoiding electric shocks and fires, electrical supply lines should be checked to identify faulty connections and worn out insulation. Rubber gloves and rubber mats should be used while working with live wires. Workers should be instructed not to touch any electrical installation in wet skin condition. There must be an adequate arrangement of first-aid and medical facilities at a remote worksite.

• SAFE HANDLING OF EQUIPMENT AND MATERIALS :

As already mentioned, no electrical equipment or installation should be touched in wet skin condition. Rubber gloves and mats should be used while handling these equipments. Similarly, in case of corrosive, reactive or toxic chemicals, protective clothing such as apron, goggles and masks must be used. Industrial activities such as welding, grinding, chipping etc. warrant very serious attention. Heavy load handling crane cables, winches, pulleys, ropes etc. should be regularly inspected and maintained. Appropriate position and posture should be taken while handling different equipments and materials, For safe handling of materials, there should be no clutter or obstructions on work areas.

OCCUPATIONAL HAZARDS

A hazard is something dangerous and likely to hurt or damage. It can cause injury, death, disease, economic loss or environmental deterioration. People working at home or other work places, face many types of hazards. However, by adopting suitable safety precautions at a work place, these hazards can be minimized to a considerable extent. The major occupational hazards are briefly described here :

• PHYSICAL HAZARDS:

These hazards are associated with environmental conditions such as light, humidity, ventilation, suspended particulate matter (SPM), noise level etc. Improper illumination may result in slips on floors and falls from elevated surfaces. Unfavourable conditions of temperature and humidity decrease the working efficiency of employees. Accumulation of different types of pollutants like smoke, metal particles, dust and other contaminant induce several health disorders, more particularly of the respiratory system. Suspended particulate matter entering the lungs may cause bronchitis, asthma, cardiovascular diseases etc. Some of the air pollutants accumulated at work place may damage the vital organ of human body. High level of noise can cause stomach disorders and high blood pressure. It may lead to partial or complete loss of hearing capacity and permanent damage to brain.

CHEMICAL HAZARDS :

In Industries associated with manufacturing of paper, fertilizers, fire crackers, pesticides, paints, pharmaceuticals etc., the workers face a number of chemical hazards. The occupational activities in

these industries include preparation and handling of toxic, explosive, highly reactive and corrosive chemicals in their solid, liquid or gas form. Exposure to these chemicals may cause eye irritation, skin burns, toxicity and respiratory disorders. Generally, the workers of a chemical industry suffer headache, cough, allergies and pain in chest. Accidental leakage of toxic chemicals may cause death and disability on a large scale. Human carelessness, unsafe activities and unsafe storage of inflammable substances may become a cause of deadly fires.

MECHANICAL HAZARDS :

These hazards are attributed to unsafe mechanical conditions and unsafe acts, deviating from the normal practices. Use of old, poorly maintained machinery and tools may prove hazardous. Unguarded machines lacking proper covers and wire meshes over their moving parts can cause serious injuries to operators. Removing, disconnecting or misadjusting the parts of a machine makes the entire operation unsafe. Failure to use body protection devices such as aprons, helmets, goggles and shoes, while working on a machine may result in death or disability. Overloading, overheating and operating the machines at an unsafe speed may prove fatal. Loose mechanical installations at worksites also threaten the life of workers.

ELECTRICAL HAZARDS :

Electrical hazards include short circuits, electrical sparks, loose connections, worn out insulation, improper earthing of machines, lack of proper guards and fencing around high voltage equipment, unsafe installations of poles and transformer etc. Electrical shocks may result in burns, disability or death. Many a times, the fire hazards in an industry are associated with electrical short circuits. It may prove very dangerous, if the workers do not use proper safety devices like rubber gloves, mats and insulated tools while repairing or operating electrical equipments. In case of electrocution, lack of adequate safety awareness among workers further increases the magnitude of problem. It generally happens that while rescuing a person, the rescue workers themselves become victims. By following proper safety precautions, electrical hazards can be avoided.

BIOLOGICAL HAZARDS :

People working in hospitals, nursing homes, clinical diagnostic laboratories, hotel laundry and sanitation services encounter biological hazards at their work place. The biowaste items such as discarded syringes, used cotton, plasters, needles, surgical instruments, bandages, body fluid samples etc. produced from hospitals and clinical laboratories, are considered very hazardous. If proper safety measures are not adopted, the associated workers may get serious infections of disease causing bacteria, viruses, fungi, protozoa and worms. Hospital solid waste is burnt at high temperature in incinerators. Incinerations reduces the volume of this hazardous waste. Biological hazards thrive in poor sanitary conditions. Use of protective clothing of safe handling of materials, good sanitary conditions, vaccination and proper management of hazardous biowaste play a major preventive role against biological hazards.

RADIATIONAL HAZARDS :

Nuclear power plants, research laboratories, weapon factories, radiological laboratories, hospital etc. are important sites which pose potential radiational hazards. Exposure of body to high dose of ionizing radiation from these sites has a number of dangerous effects. It may cause cancer of different body parts such as bone, skin, lung and breast. The other effects include damage to brain, eyes, intestinal lining, blood cells and reproductive organs. It may produce mutations in genetic material, producing birth defects, mental retardation and genetic disease in future generations. Incorporation of safety features in the structural design of nuclear reactors, sound technical understanding and safety precautions can help in mitigating radiational hazards.

PSYCHOLOGICAL HAZARDS :

Work related stress is a major psychological hazard that can lead to serious health disorders and psychological disturbances. It gives rise to depression, nervousness, anxiety, fatigue, irritation, imbalanced behaviour etc. A number of external and internal factors contribute towards work related stress. Unfair distribution of work, inadequate welfare facilities, unsafe work environment, pending assignments, nature of job, financial crisis, poor management of organization, family problems and inter-personal disputes are major stress generating factors. Unmarried workers feel more stressed than married workers. In comparison to male workers, female workers feel less stressed. Stress ultimately leads to poor performance, thus reducing the productivity of an organization. A safe and comfortable work environment, consultative management approach, genuine work targets and proper employee welfare policies are helpful in coping work related stress.

EXERCISE

(A) Very short answer type questions (1 mark each) :

1. What is the significance of safe work environment?
2. Write two important causes of industrial accidents.
3. Name important components of a safe work environment.
4. What is the harm of flickering lights at a work place?
5. How does natural ventilation take place?
6. Write the major objective of good housekeeping.
7. What is a workshop?
8. What do you mean by a hazard?

(B) Short answer type questions (2 marks each) :

1. What are the effects of fluorescent lights at a work place?
2. What is ventilation?

3. Why should inflammable materials not be stored near electric outlets?
4. Why should an operator wear an apron?
5. Enlist major types of occupational hazards.
6. How can radiation exposure effect the future generations?

(C) Short answer type questions (4 marks each):

1. Write a short note on role of adequate light in creating safe work environment.
2. Discuss briefly the need of proper ventilation.
3. How does good housekeeping reduce the chances of industrial accidents?
4. Enlist some safety precautions that should be followed at home.
5. How can the workers in a workshop prevent injuries?
6. What safety precautions should be taken at a worksite?
7. Make a brief mention of some electrical hazards.

(D) Long answer type questions: (5 marks each):

1. Discuss adequate light and proper ventilation as components of safe work environment.
2. How does cleanliness and good housekeeping help in creating a safe work environment?
3. Discuss some common safety precautions that must be followed at different work places.
4. Make an account of different types of occupational hazards.



SAFETY LAWS, ACCIDENTS AND FIRST-AID

India as a nation is committed to the welfare and development of its people. Our constitution guarantees, besides other rights, protection of life, personal liberty and provides adequate safeguards against occupational hazards and injuries. Keeping in view the constitutional obligations, the Parliament and the State legislature have enacted laws for the safety of workers and betterment of environment.

OCCUPATIONAL SAFETY

- (i) **Safety in industries :** This is generally ignored under the labour laws. The first such act is The Factories Act, 1948. It is a principal legislation for regulating and ensuring various aspects relating to safety, health and welfare of the workers employed in different factories. This Act is central enactment aimed at protecting workers employed in factories from industrial and occupational hazards. The State governments and the Union Territory administration also frame rules under the Act and enforce provisions of the act and rules through factory inspectors. The Factories Act was amended in 1987 in order to impose some conditions on the employers to ensure the health and safety of the workers. A new chapter for regulating safety and health aspect in hazardous industries was incorporated in this Act.
- (ii) **Safety at the ports and docks :** The Workers Act, 1986 has provisions relating to safety and health of dock workers. This act came into being on 15th April, 1987. The Manufacture, Storage and Import of Hazardous Chemicals Rules, 1989 framed under the Environment (Protection) Act, 1986 also ensure a safe working environment.
- (iii) **Safety in mines :** For safety and health of mine workers. The Mines Act was framed in 1952. Under this Act, there are provisions for (a) investigations of all fatal accidents (b) grant of statutory permission, exemption, relaxation in respect of various mining operations and (c) approval of mines safety equipment, appliances and materials.

Under the Environment (Protection) Act, 1986 various policies and programmes have been formulated. The main objective of such policies is to promote safe handling, management and use of hazardous substance and wastes in order to prevent potential damage to the health of workers and the general environment. The rules are implemented in association with the Central and State Pollution Control Boards. If needed, the rules can be modified from time to time to rationalize and streamline the policies and programmes to ensure proper management of hazardous substances.

Most of the States have constituted their State level crisis groups. Under the Public Liability Insurance Act, 1991 as amended in 1992, all major accident hazard units handling chemicals in excess of threshold quantities referred to in the schedule are mandated to take an insurance policy and deposit an equal amount in the Environment Relief Fund to ensure immediate payment to chemical accident victims.

For an overall safety of workers, the Ministry of Labour constituted the National Safety Council in 1966 to promote safety consciousness among workers to prevent accidents and minimize dangers to mitigate human sufferings. Under the programme, lectures and conferences on safety are arranged to raise awareness amongst employers and the workers. Each year the National Safety Day is celebrated on 4th March to mark the foundation day of the National Safety Council.

ACCIDENTS AND MAJOR OCCUPATIONAL HAZARDS

Many industries and other occupation make materials which do not exist in nature. In order to avoid accidents causing harm to the workers and the environment, such materials require careful handling during manufacture, transport, storage, use and disposal. Many of these chemicals are not biodegradable and have the potential to cause adverse health effects and remain in the environment for decades. The release of these materials may occur by spilling, leaking, emitting toxic vapours or any other process that enables the materials to escape from the container which results in creating a potential hazard. The main accident causing hazards are divided into three categories.

- (i) **Explosives** : The substances that release gas and heat suddenly when they are subjected to heat, shock or high pressure are called as explosives. Explosives with a mass explosion hazard are tri-nitro-toluene (TNT) and Tri-nitro-glycerin. Explosive with projection hazards but not a mass explosion are bombs, grenades, anti-hail rockets etc. The explosives having both the above mentioned properties include propellant and display fireworks. The workers handling such materials must see the label on the containers and strictly observe the instructions mentioned for their use.
- (ii) **Flammables and combustibles** : These are substances which are easy to ignite and can be gases, liquids or solids. The flammable gases are those which are compressed, liquefied or dissolved under pressure. Such gases on contact with ignition source produces fire, e.g. acetylene, hydrogen, liquefied petroleum gas etc. The flammable liquids include diethyl ether, carbon disulphide, petrol, acetone, methylated spirit, kerosene, turpentine etc. The flammable solid substances include nitrocellulose, phosphorus, matches, aluminium, alkyls, calcium carbide etc.

The workers of such industries should wear masks against inhalation of gases. They should wear fire resistant clothes. As per the international laws such substances are labelled as shown in fig. (16.1). Workers should handle such substances very cautiously.



Fig. 16.1 Some international labels

(iii) **Toxic materials or poisons :** Toxic materials can cause injury or death when they enter the bodies of living beings, including man. The poisonous substances causing death or serious injury to human health are cyanides and lead compounds. Some toxic substances that do not cause death but are otherwise harmful to human health include various pesticides and biomedical wastes like vaccines and pathogenic organisms. The poisonous gases that can cause death or serious injury to health if inhaled are ammonia and chlorine. Workers handling such materials should see the labels carefully and should follow proper procedure for their disposal.

The hazardous substances can enter the body in any of the following entry routes:

- (a) Absorption through skin and eyes : If a worker walks barefoot on the floor of industry, the contaminants spilled on the floor will come in contact with the skin of the feet. It can cause irritation, burns, sores or ulcers on the skin. Similarly, workers not using gloves while handling the poisonous chemicals are also prone to such accidents. Such workers should never put their hands on the eyes without proper washing, as the eyes are very sensitive to toxic substances.
- (b) Injections : In industries, various toxic substances get injected directly through the cut skin and enter into blood stream while handling contaminated cans.

- (c) Ingestion : In some industries or work places, there are chances of toxic substances entering through ingestion. An example of inadvertent ingestion is a battery factory employee who eats lunch in the work area and ingests lead which has contaminated the food and water.
- (d) Inhalation : Some of the hazardous substances, especially gases such as hydrogen sulphide, carbon monoxide etc. enter the into the lungs through inhalation. The workers of all such industries should follow the first-aid rules as given below.

FIRST-AID

To provide first-aid service is an essential part of every industry and workplace to meet out emergent situations. The extent of this service may vary from place to place, but an identification of hazards, risk assessment and risk control processes used for providing information are basically same for different industries and work places. In this chapter, information is given about equipment, facilities and training for the persons delivering the first aid.

- (i) **Definition :** As per the International Labour Organisations (ILO), first-aid is an immediate and temporary care of a victim of an accident, with the aim of preventing or reducing an acute threat to the life. It is provided by a person who may not be a physician but a trained 'first-aider'.

Keeping industrial and occupational hazards in view, almost all the countries of the world including India have made the provision of first aid service in work places mandatory through legislation.

- (ii) **Aims of first-aid :** The main aims of the first aid service are as follows:
 - (i) To save the life of the employees of the industry or the work place and also to take care of people other than employees e.g. children and parents in a school and customers in a shop etc.
 - (ii) To protect the unconscious people and to see that their condition may not become worse.
 - (iii) To relieve pain and suffering of affected people and to promote their recovery.
- (iii) **Planning of first-aid services :** Planning is a part of safety management system with the main focus on prevention of accidents. The areas to be covered under the emergency management plan are:
 - Rescue activities
 - Evacuation procedures
 - Transport to the nearest hospital or medical centre
 - Control of fire, gas leakage and flooding
 - Contact with relatives

- Arrangement systems
- Security

Another component of planning emergencies and developing first-aid facilities is consultation between the employers and workers. Their involvement in planning helps in understanding and commitment of the provisions of first aid. All workers at the work place need to have information and instructions on as how the system works so that they are able to use it without delay, whenever needed. It can be included in induction programmes for new workers. All those workers who work alone in an isolated workplace should be more cautious about first-aid training. For example, a worker working in a farm should know what to do in case of a snake bite.

The identification of hazard is also an essential component of planning. The hazards can be mechanical, toxic chemicals or noise etc. Other hazards may result from equipment failure or misuse, power system failure and chemical spills etc.

It is thus emphasized that good planning and provision of first-aid service can reduce the severity of injuries and disease at a work place.

(iv) Establishment of first aid service : To provide first aid service at a work place is the primary responsibility of an employer. The employer should appoint first-aider and should delegate some specific duties to the workers. All the workers should be provided with practical training of first-aid. Workers must be informed about the location of first-aid boxes. All employees must be told about the names of the first-aiders, their contact number and address so that they can be contacted immediately when an emergency arises. This above information can be provided through:

- Introduction programmes
- Awareness sessions
- News-letters
- Staff meetings
- Notice board and announcements: The information must be given in a simple language so that it can be understood by all the workers.

The duties of the workers are complimentary to the duties of the employer.

- The workers should know the location of first-aid room, first-aid facilities, names and address of the first-aiders.
- To make sure that the first-aid facilities are not misused.
- They should carefully follow the instructions and directions given by the first-aider.
- They should report all cases of injuries to the first aider whether treatment may be required or not.

(v) **First Aider:** First aider is the person responsible for providing an immediate medical care at the place of accident. A good first aider should have following capabilities:

- Should remain calm in an emergency situation.
- Should be able to provide appropriate assessment in an emergency.
- Should physically handle rescue situations.
- Should take care and control casualties during such emergencies.

The duties of a first-aider can be divided into two categories.

(a) The duties during normal times are:

- To provide regular feedback to management regarding the provisions of first-aid services.
- To identify areas likely to give rise to injury or work caused illness.
- To review the safety methods for preventing the accidents.
- To identify as to whom the facilities are most needed.
- To arrange training programmes for workers regarding safe and healthy practices to be followed
- By taking workers into confidence, the first-aider should maintain a personal health record of each worker that will help him during any accident or emergency.

(b) The duties at the time of an accident or emergency are:

- To immediately attend to the injuries and diseases occurring at the work place.
- To ensure that management has established contacts with emergency service like fire brigade, ambulance, police and hospitals etc.
- To take the help of workers who are not affected in the accident.
- To prepare the record of all injuries which are to be referred to the hospital.
- To follow the legal principle which states that first-aiders should act reasonably with a genuine concern for the best interests of the victims.

(vi) **Equipment and facilities :** The equipment and facilities to be provided shall vary from industry to industry and from place to place. The equipment and facilities include first-aid box, first-aid room, communication system and eye wash stations etc.

- **First-aid box :** It is the foremost requirement of each work place and industry. The first aid box should contain sufficient quantity of materials required at a work place. It should be replenished as soon as the material has been used. The out dated medicines and damaged material should be replaced. It should be handy and kept at a place of immediate access.
- **First aid room :** The first-aid room should meet the following requirements: '

- (i) It should be under the command of a qualified first aider. The person should be available at all times when workers are on duty at a workplace.
 - (ii) It should be well ventilated, heated/cooled and well lighted.
 - (iii) It should be cleaned and washed regularly.
 - (iv) It should have sufficient equipment like stretchers, wheel chairs, beds etc.
 - (v) The room should be located at a suitable site having access for transport to hospital and easily accessible to injured workers.
 - (vi) The room should be large enough to contain an examination table with a sufficient space for people to walk around.
- **Communication means:** Effective means of communication should be provided in the industry or the working place so that during an emergency an immediate contact can be made with the first-aider and the first-aid room.
 - **Eye wash station :** Besides the first-aid room, eye wash stations may be provided at different points throughout the working place.
- (vii) Protection of first-aider:** The first aider himself is exposed to many injuries and infections. It is a common assumption that all blood and body fluids are a potential source of many infections, especially the viral infections like Hepatitis, Herpes, HIV or AIDS etc. Thus it is very essential to ensure that the first aider should be provided with adequate information and training for self protection. The first-aider should wear disposable gloves to reduce the risk of cross infection. The waste contaminated with blood and body substances and the items like needles and other sharp instruments should be properly disposed off.
- (viii) Training of first-aider :** It is a very important aspect of bio-safety that the first-aider should be well trained for the basic level of first-aid and possess training according to the needs of the work place. It is the duty of the employer to ensure that the training be got imparted from some recognised institute of repute. The training should include first-aid management of fractures, traumatic amputation, shock, injuries, strains and sprains, electric shock, spinal injury, poisoning, bites and stings, eye injuries, ear injuries, open wounds, choking, medical emergencies like asthma, diabetes, allergies etc.

EXERCISE

(A) Very short answer type questions (1 mark each) :

1. What are explosives?
2. Name the Act associated with protection of environment.
3. When was the Factories Act enacted?
4. Name two toxic solids.

5. On which day the National Safety Day is celebrated?
6. Name two poisonous gases.

(B) Short answer type questions (2 marks each) :

1. What are toxic or poisonous substances?
2. How are the hazardous substances released into the environment?
3. What is first-aid?
4. Suggest two safety precautions for industrial workers who handle toxic substances.
5. Write about the first-aid related duties of an industrial worker.

(C) Short answer type questions (4 marks each):

1. How do the hazardous materials enter the body?
2. How can an employer spread awareness about first-aid?
3. What are the flammable and combustible substances?
4. What are the main aims of first-aid?
5. How can a first-aider ensure his safety?
6. Write a brief note on qualities of a good first-aider.

(D) Long answer type questions: (5 marks each):

1. Discuss some accident causing hazardous substances.
2. What are the different duties of a first-aider?
3. Write about some important first-aid equipments and facilities.



CHAPTER-17

DRUGS-ILL EFFECTS-I

“Health is a state of complete physical, mental and social well-being and not merely the absence of disease or infirmity” (WHO). A healthy person is an asset to society. He or she can serve the nation better. Healthy people are more productive, they can contribute in the progress of the country.

A healthy mind resides in a healthy body. Poor physical health can affect self-esteem and ability to meet goals which leads to unhappiness and depression. Mental health also gets affected by the use of some kind of drug/alcohol. Addiction of the drug/alcohol leads to physical and mental illness. Poor physical/mental health of a person affects the society in many ways. At lower level it causes suffering for the individual, his family and immediate social circle. At higher level it causes much loss to society in terms of wasted man power and productivity which in turn threatens to distort or destabilize the social and economical structure of entire nation as whole.

An addiction can be classified as a mental illness. Like other mental illnesses drug addiction affects people from all ethnic, cultural and socioeconomic backgrounds. An alarming increase of drug abuse has been reported in recent years. According to the different reports of electronic and print media, the increasing number of youngsters being held for taking drugs aged between 17-19, is a matter of concern.

World Health Organization defines substance abuse as “Persistent or sporadic drug use inconsistent with or unrelated to acceptable medical practice.”

The term ‘Drug’ used originally to mean ‘medicine’ but now a days it is used not only for medicine, but also for the narcotics like cocaine, heroin, brown sugar etc.

The habit of becoming dependent on drugs is known as Drug Addiction and a person who has become dependent on the drug, is called a drug addict. The addict uses it having knowledge of its adverse effects.

When people cross the line from occasional to frequent, it becomes abuse. The drugs of abuse excite the parts of the brain that make a person feel good. But, after they take a drug for a while, the feel-good parts of their brain get used to it. The brain wants them to repeat things that we need or enjoy.

Drug addiction is a problem prevalent among teenagers as well as adults. Some of the factors responsible for this can be:

- Use of drugs by friends and family members increases the risk of drug addiction.
- Sometimes failures at work can also be a reason.
- Disturbed family life can get a person into this trouble.

- Persons having problems relating to mental health such as attention deficit, depression or anxiety may use drugs to feel better.
- Use of drugs for fun by youngsters can increase their chances of becoming addicts.
- Sometime parental burden to excel in exams also creates an unnecessary pressure on the child and the inability to cope up with this pressure, makes them resort to drugs.

COMMON SYMPTOMS OF THE DRUG ADDICTS :

- Loosing temper easily
- Getting into fights and other illegal activities more often.
- Neglecting responsibilities at home and workplace.
- Experiencing weight loss, lack of sleep and appetite.
- Deteriorating physical appearance.

The initial decision to take drugs is voluntary for many but the continuous use of drugs make them addicts. An addict uses drugs, despite having knowledge of its bad effects on physical and mental health as he/she becomes a drug-dependent.

Drugs affect not only the addict but also his/her family, friends and society as a whole. A drug addict becomes selfish, self-centered and insensitive to others. Drugs can lead to financial hardships and distress, negative effect on family life, education, mental and physical well-being.

Important days relating to drug awareness
 May 31 : Anti-tobacco Day
 June 26 : International Day against Drug Abuse and Illicit Trafficking



Pictorial Anti-Tobacco Warning on a cigarette pack

A list of common 'Drugs of Abuse' is given below:

1. Alcohol
2. Opioids
3. Cannabis
4. Sedative hypnotics
5. Cocaine
6. Hallucinogens
7. Tobacco
8. Volatile solvents

PREVENTION

The youth must be taught about the harmful consequences of drugs to prevent the drug addiction among them. The awareness programmes at school and college level can become a tool to reduce the problem of drug addiction among youth.

1. The best tool against developing an addiction is to avoid drugs.
2. Be strong to say 'No'. Avoid negative peer pressure.
3. Avoid people who insist you to use alcohol or drugs.
4. Make new friends who practice healthier habits. Do well in school. Stay motivated at work.
5. Make plans for your future, set goals for your life and work hard to achieve them
6. Be a role model and set a positive example.
7. Discuss openly about drugs with your parents and teachers. Don't rely on misconceptions.
8. If you feel depressed, anxious or have some other mental health problem, look for a reliable and healthy source of support. Discuss with your parents, teachers or approach a counselor if needed.
9. Speak out, if you or your friend is suffering due to drugs, don't hesitate to seek help.
10. Adopt a healthier lifestyle by eating well and exercising.
11. Never try to self-medicate your physical or mental discomfort.

When someone stops using the drug, he/she might feel very sick for some time and feel a very strong need to take the drug. So, the quitting from drugs seems very difficult, that's why people don't try. They are afraid of what will happen if they don't take drugs.

With the help of family members and friends, doctors or counselors and the people who had stopped taking drugs, one can quit drug abuse. Parents must motivate their children as they are the closest source to them. They should always be there for their children because youngsters are highly susceptible to the drug abuse.

‘ਸਮਾਜਿਕ ਨਿਆਂ ਅਧਿਕਾਰਤਾ ਅਤੇ ਘੱਟ ਗਿਣਤੀ ਵਿਭਾਗ’, ਪੰਜਾਬ

INITIATIVES BY GOVERNMENT

The Government has taken various initiatives through the Department of Health and Family Welfare for spreading awareness and educating people about ill effects of drug use through various preventive health education efforts:

A holistic approach is followed deal with the addicts which includes counseling, treatment, follow up and social reintegration of recovered addicts.

Display of “Tobacco Free School/Tobacco Free Institution” boards at prominent places.

Ban on sale of any kind of drugs within 100 yards of school premises.

Ban on the sale of tobacco or other such products to the individuals below the age of 18 years.

EXERCISE

1. What are behavioral changes that occur in drug abuse?
2. Which day is observed as ‘Anti Tobacco Day’?
3. What are drugs of abuse according to WHO?
4. What is health?
5. How can we say that drug addiction is personal as well as a social loss?
6. What are factors responsible for making a person drug addict?
7. List the common symptoms of a drug addict?
8. What are the preventive measures to escape from drugs?
9. What are the initiative of governments in relation to drug abuse?

